

# **Husqvarna**

## **FOREST & GARDEN**



# **36/41**

## **Operator's manual**



# Before using your new chain saw



- **Read the Operator's Manual carefully.**
- Check the assembly and adjustment of the cutting equipment (page 6).
- Start the saw and check the carburettor adjustment (page 16-17).
- Do not start sawing until a sufficient amount of chain oil has reached the chain (page 7,12-13).

**IMPORTANT!** A too lean carburettor adjustment increases the risk of serious engine malfunction. Insufficient air filter maintenance increases the deposits on the spark plug. This can cause starting difficulties. Incorrectly adjusted chain increases the wear and damage on the bar, the drive sprocket and the chain.

You will find one or more of the following warning labels on the saw in black printing on yellow background.

## USA



## CAN

 **WARNING** 

Avoid contact between any object and the guide bar tip. Contact can cause the chain and guide bar to suddenly move upward and backward, which may cause serious injury. Use both hands on the handles. Follow all safety precautions in the operator's manual. Failure to follow instructions could result in serious personal injury.

Recomm. for **Husqvarna 36**

Chain / Bar length / Bar nose sprocket  
**Husqvarna H30** / 16" / Max 10 teeth or  
**Husqvarna H30** / 18" / Max 10 teeth  
 Other low kickback comb. in operator's manual.

 **WARNING** 

Avoid contact between any object and the guide bar tip. Contact can cause the chain and guide bar to suddenly move upward and backward which may cause serious injury. Use both hands on the handles. Follow all safety precautions in the operator's manual. Failure to follow instructions could result in serious personal injury.

Recomm. for **Husqvarna 41**

Chain / Bar length / Bar nose sprocket  
**Husqvarna H30** / 16" / Max 10 teeth or  
**Husqvarna H30** / 18" / Max 10 teeth  
 Other low kickback comb. in operator's manual.

**CAUTION!**  **ATTENTION!**

For safe operation follow all safety precautions and instructions in operator's manual.

Pour la sécurité d'opération, observez tous les règlements et les instructions dans le manuel de l'utilisateur.

Chainsaws can be dangerous!  
 Les tronçonneuses peuvent être dangereuses!

Displacement below 3.8 cubic inches (62.3 cc) which comply with the kickback requirements of American National Standards Institute B 175.1 – 1991.

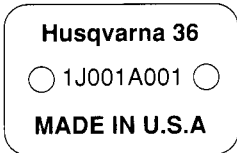

### SERIAL No-PLATE

Each saw has a nameplate, fixed to the crankcase, with saw model identification and serial number. On this plate is also the country of manufacturing identified.

## Index

Before using your new chain saw .....	3
Safety Precautions .....	4
What is what on the saw .....	5
Technical specification .....	5
Mounting guide bar and chain .....	6
Fuelmix and chain oil .....	7
Start and stop .....	8
Chain brake .....	9
Control and maintenance of the chain brake .....	9
Maintenance and function .....	10
Starter device .....	11
Chain maintenance .....	12-13
Maintenance .....	14-15
Carburettor .....	16-17
Equipment needed .....	18
General working instruction .....	19-22

# Safety Precautions

## (ANSI B 175.1 - 1985 Appendix D)

### Safety Precautions for Chain Saw Users

#### D 1. Kickback Safety Precautions

**⚠ WARNING!:** KICKBACK may occur when the nose or tip of the guide bar touches an object, or when the wood closes in and pinches the saw chain in the cut.

- Tip contact in some cases may cause a lightning fast reverse REACTION, kicking the guide bar up and back towards the operator.
- Pinching the saw chain along the top of the guide bar may push the guide bar rapidly back towards the operator.
- Either of these reactions may cause you to lose control of the saw which could result in serious personal injury.

Do not rely exclusively upon the safety devices built into your saw. As a chain saw user, you should take several steps to keep your cutting jobs free from accident or injury.

- (1) With a basic understanding of kickback, you can reduce or eliminate the element of surprise. Sudden surprise contributes to accidents.
- (2) Keep a good firm grip on the saw with both hands, the right hand on the rear handle, and the left hand on the front handle, when the engine is running. Use a firm grip with thumbs and fingers encircling the chain saw handles. A firm grip will help you reduce kickback and maintain control of the saw. Don't let go.
- (3) **Make sure that the area in which you are cutting is free from obstacles. Do not let the nose of the guide bar contact a log, branch, or any other obstruction that could be hit while you are operating the saw.**
- (4) Cut at high engine speeds.
- (5) Do not overreach or cut above shoulder height.
- (6) Follow manufacturer's sharpening and maintenance instructions for the saw chain.
- (7) Only use replacement bars and chains specified by the manufacturer or the equivalent.

#### D 2. Other Safety Precautions

- (1) Do not operate a chain saw with one hand! Serious injury to the operator, helpers, bystanders, or any combinations of these persons may result from one-handed operation. A chain saw is intended for two-handed use.
- (2) Do not operate a chain saw when you are fatigued.
- (3) Use safety footwear; snug-fitting clothing; protective gloves; and eye, hearing, and head protection devices.

- (4) Use caution when handling fuel. Move the chain saw at least 10 feet (3 m) from the fueling point before starting the engine.
- (5) Do not allow other persons to be near the chain saw when starting or cutting with the chain saw. Keep bystanders and animals out of the work area.
- (6) Do not start cutting until you have a clear work area, secure footing, and a planned retreat path from the falling tree.
- (7) Keep all parts of your body away from the saw chain when the engine is running.
- (8) Before you start the engine, make sure that the saw chain is not contacting anything.
- (9) Carry the chain saw with the engine stopped, the guide bar and saw chain to the rear, and the muffler away from your body.
- (10) Do not operate a chain saw that is damaged, improperly adjusted, or not completely and securely assembled. Be sure that the saw chain stops moving when the throttle control trigger is released.
- (11) Shut off the engine before setting the chain saw down.
- (12) Use extreme caution when cutting small size brush and saplings because slender material may catch the saw chain and be whipped toward you or pull you off balance.
- (13) When cutting a limb that is under tension be alert for springback so that you will not be struck when the tension in the wood fibers is released.
- (14) Keep the handles dry, clean, and free of oil or fuel mixture.
- (15) Operate the chain saw only in well-ventilated areas.
- (16) Do not operate a chain saw in a tree unless you have been specifically trained to do so.
- (17) Do not operate a chain saw above shoulder height.
- (18) All chain saw service, other than the items listed in the operator's/owner's safety and maintenance instructions, should be performed by competent chain saw service personnel. (For example, if improper tools are used to remove the flywheel or if an improper tool is used to hold the flywheel in order to remove the clutch, structural damage to the fly-wheel could occur and subsequently cause the flywheel to burst.)
- (19) When transporting your chain saw, use the appropriate guide bar scabbard.

**Note:** This Annex is intended primarily for the consumer or occasional user.

**For further safety precautions and basic cutting operations see: Operator's Safety Manual.**

# What is what on the saw

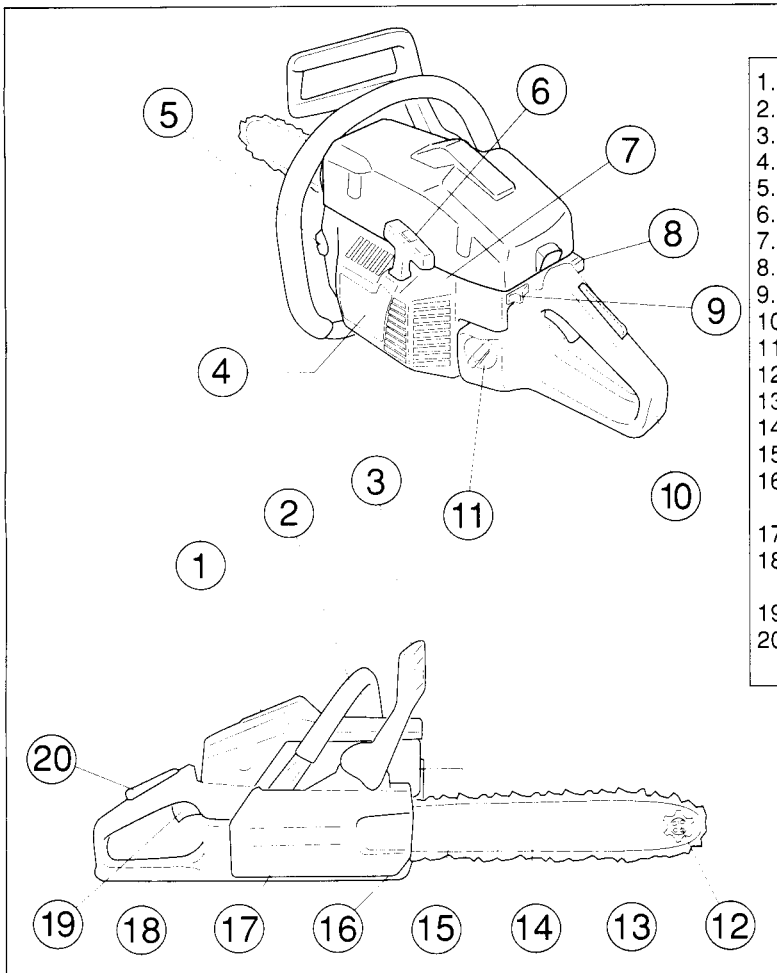

1. Cylinder cover.
2. Front handle.
3. Front hand guard.
4. Starter.
5. Chain oil tank.
6. Starter handle.
7. Adjustment screws, carburettor.
8. Choke/Throttle latch
9. Stop switch. Switches the ignition on and off.
10. Rear handle.
11. Fuel tank.
12. Sprocket nose.
13. Saw chain.
14. Guide bar.
15. Muffler.
16. Chain catcher. Catches the chain if the chain jumps or breaks.
17. Clutch cover with a built-in chain brake.
18. Chain guard. Protects the right hand if the chain breaks or jumps.
19. Throttle trigger.
20. Throttle trigger lockout. Prevents unintentional throttle movement.

## Technical specification

<b>Engine</b>		<b>36</b>	<b>41</b>
Displacement	cu.in/cc	2.2/36	2.4/40
Bore	mm	38	40
Stroke	mm	32	32
Idling Speed	rpm	3000	3000
Recommended max speed unloaded	rpm	13.000	13.000
<b>Ignition system</b>			
Manufacturer/type of ignition system	Phelon	CD	CD
Spark Plug	Champion	RCJ7Y	RCJ7Y
Electrode Gap	in/mm	0.02/0,5	0.02/0,5
Timing		Fixed; Nonadjustable	
<b>Fuel and lubrication system</b>			
Manufacturer/type of carburettor	Walbro	WT 239	WT 239
Fuel tank volume	pint/litre	0.73/0,40	0.73/0,40
Oil pump capacity at 8000 rpm	cc/min	6-8	6-8
Oil tank volume	pint/litre	0.36/0,20	0.36/0,20
Oil pump type		automatic	automatic
<b>Weight</b>			
With guide bar and chain, 16"	lbs/kilos	12.1/5,5	12.1/5,5
<b>Chain and guide bar</b>			
Standard bar length	in/cm	16/41	16/41
Recommended bar lengths	in/cm	15/38	15/38
		16/41	16/41
		18/46	18/46
Chain speed at max power	m/sec, t	16.3, 7t	16.3, 7t
Pitch	in	3/8	3/8
		.325	.325
Thickness of driving links	in/mm	.050/1,3	.050/1,3
		.058/1,5	.058/1,5

# Mounting guide bar and chain

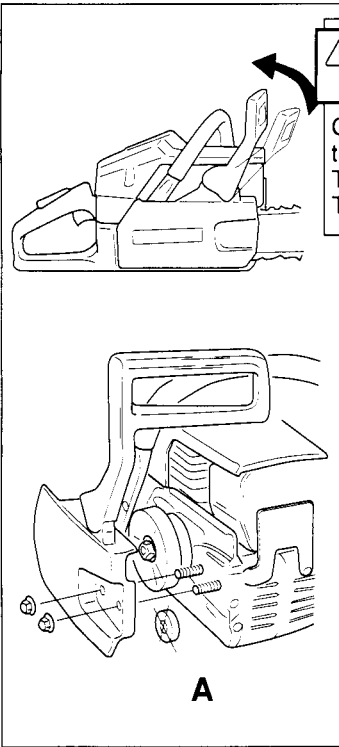

**⚠ WARNING!** Always wear gloves, when working with the chain, in order to protect your hands from injury.

Check that the chain brake is in disengaged position by moving the front hand guard towards the front handle.  
Take off the bar nuts and remove the clutch cover (chain brake).  
Take off the transportation ring (A).

Fit the bar over the bar bolts. Place the bar in its rearmost position. Place the chain over the drive sprocket and in the groove on the bar. Begin on the top side of the bar. Make sure that the edges on the cutting links are facing forward on the top side of the bar.

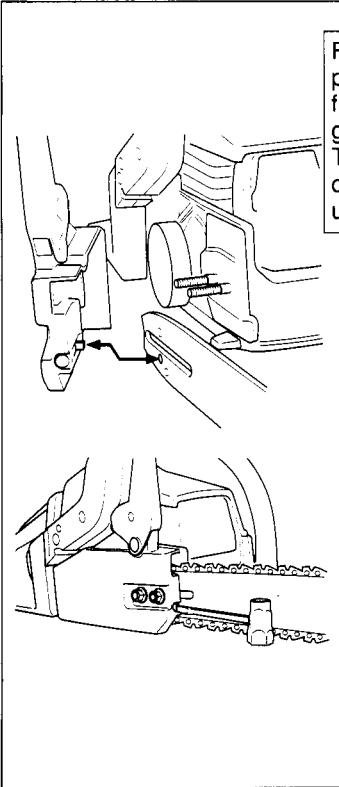
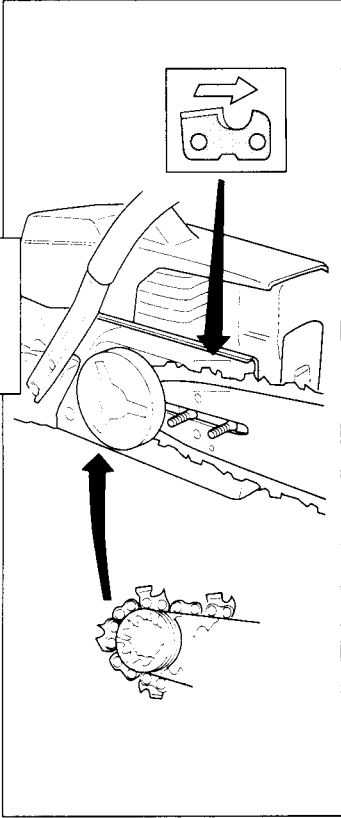

Fit the clutch cover (chain brake) and locate the chain adjuster pin in the hole on the bar. Check that the drive links of the chain fit correctly on the drive sprocket and that the chain is in the groove on the bar. Tighten the bar nuts finger tight. .  
Tension the chain by using the combination wrench. Turn the chain adjuster screw clockwise. The chain should be tensioned until it fits snugly on the underside of the bar.

Hold up the tip of the bar and tighten the chain. The chain is correctly tensioned when there is no slack on the underside of the bar, but it can still be turned easily by hand. Hold up the bar tip and tighten the bar nuts with the combination wrench.  
When fitting a new chain, the chain tension has to be checked frequently until the chain is run-in.  
Check the chain tension regularly. A correctly tensioned chain gives good cutting performance and long lifetime.

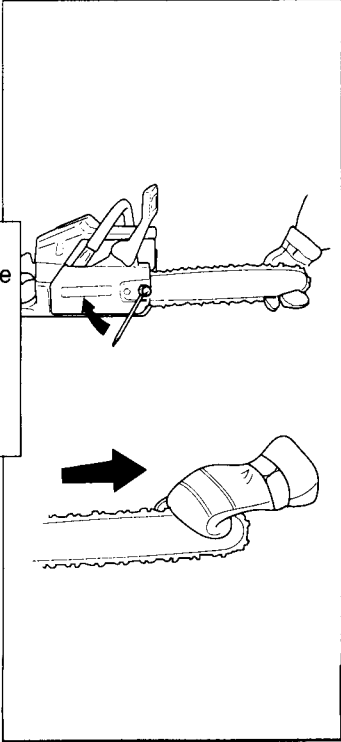

# Fuelmix and chain oil

**⚠ WARNING!** The chain saw is equipped with a two-stroke engine. Always run the saw with fuel, which is mixed with oil. Provide for good ventilation, when fueling or handling fuel.

## Fuel

Always use a regular unleaded gasoline with minimum octane number of 90. This engine is certified to operate on unleaded gasoline.

## Two-stroke oil

- For the best performance, use Husqvarna two-stroke oil, which is especially developed for chain saws. Mixing ratio 1:50 (2%).
- If Husqvarna two-stroke oil is not available, you may use another two-stroke oil of good quality. Mixing ratio 1:33 (3%).
- In countries where no two-stroke oil is available, motor oil SAE 30 can be used. Mixing ratio 1:25 (4%).
- Never use multi-grade oil (10 W-30) or waste oil.
- Always mix fuel and oil in a clean container.
- Always start by filling half the amount of fuel, which is to be used. Then add the whole amount of oil. Mix (shake) the fuel mixture. Add the remaining amount of fuel.
- Mix (shake) the fuel mix thoroughly before filling the fuel tank on the saw.

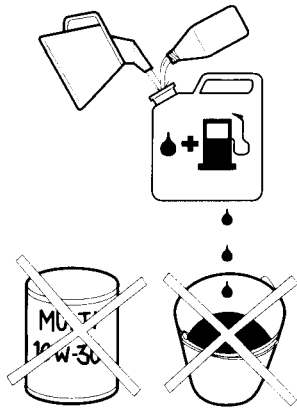

Gasolin Benzin Essence Gasolina Lit.	Oil • Öl • Huile • Aceite Lit.			
	2%(1:50)	3%(1:33)	4%(1:25)	5%(1:20)
5	0,10	0,15	0,20	0,25
10	0,20	0,30	0,40	0,50
15	0,30	0,45	0,60	0,75
20	0,40	0,60	0,80	1,00

## Chain oil

- The chain lubrication system is automatic. Always use special chain oil with good adhesive characteristics.
- In countries where no special chain oil is available, gear box oil EP 90 can be used.
- Never use waste oil. This results in damage to the oil pump, the bar and the chain.
- It is important to use oil of the right viscosity according to the air temperature.
- In temperatures below 0°C (32°F) some oils become less viscous. This can overload the oil pump and result in damage to the oil pump components.
- Contact your servicing dealer when choosing chain oil.

## Fueling

- ⚠ WARNING!**
- Always shut off the engine before refueling.
  - Slowly open the fuel tank, when filling up with fuel, so that possible over- pressure disappears.
  - Tighten the fuel cap carefully, after fueling.
  - Always move the saw away from the fueling area before starting.

Before fueling, clean the tank cap area carefully, to ensure that no dirt falls into the tank and causes malfunction. Make sure that the fuel is well mixed by shaking the container, before fueling. The volume of the chain oil tank and the fuel tank are adjusted to each other. Therefore, always fill up with chain oil and fuel at the same time.

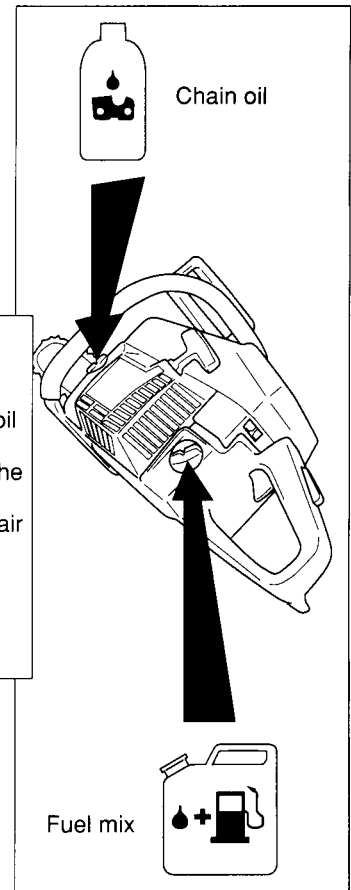

Min 3 m  
(10 ft)

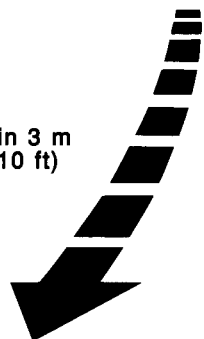

# Start and stop

## Start and stop

### ⚠ WARNING!

- Never start the saw engine without the bar, chain and clutch cover (chain brake) assembled - or else the clutch can come loose and cause personal injuries.
- Always move the saw away from the fueling area before starting.
- Place the saw on clear ground and make sure that the chain is not contacting anything. Also, make sure that you have a secure footing.
- Keep people and animals well away from the working area.

### Start

Grip the front handle with your left hand and hold the saw down by putting your right foot in the rear handle. Pull the starter handle with your right hand and pull out the starter cord slowly until the starter pawls engage. Then pull sharply. Push in the choke control immediately when the engine ignites and make repeated starting attempts. When the engine starts, rapidly give full throttle. Then the throttle latch will disengage. CAUTION! Do not release the starter handle from fully pulled out position as this can cause damage on the saw.

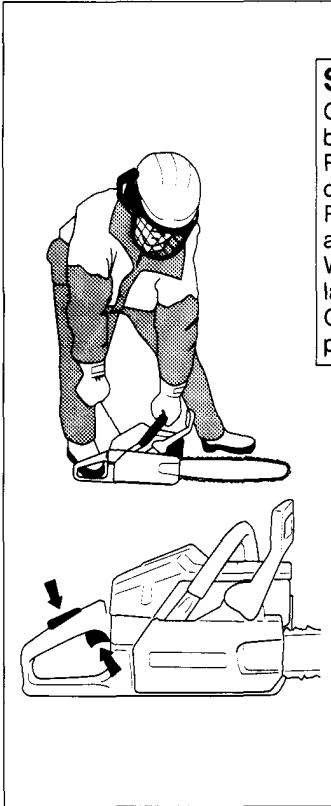

### Cold engine

- CHAIN BRAKE:** Disengage the chain brake by pulling the hand guard towards the front handle.
- IGNITION:** Move the ignition switch to the left.
- CHOKE:** Pull out the choke control
- FAST IDLE:** Combined choke/fast idle is received when the choke is moved to choke position.

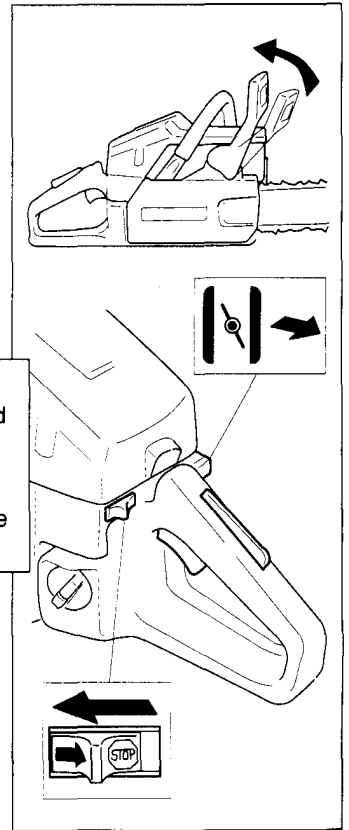

### Warm engine

Use the same procedure as for starting cold engine but without choke. Fast idle is received by pulling out the choke fully first, and then pressing it back again.

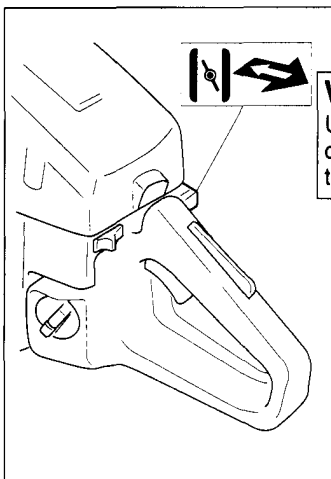

### Stop

The engine is stopped by switching off the ignition. (Move the ignition switch to the right.)

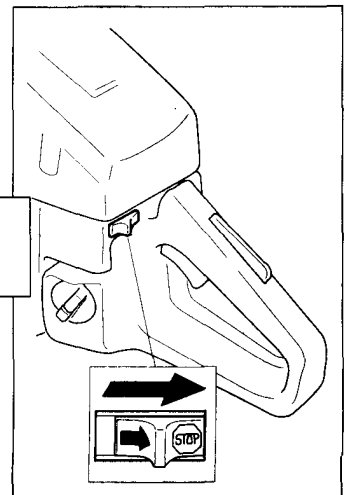



# Chain brake

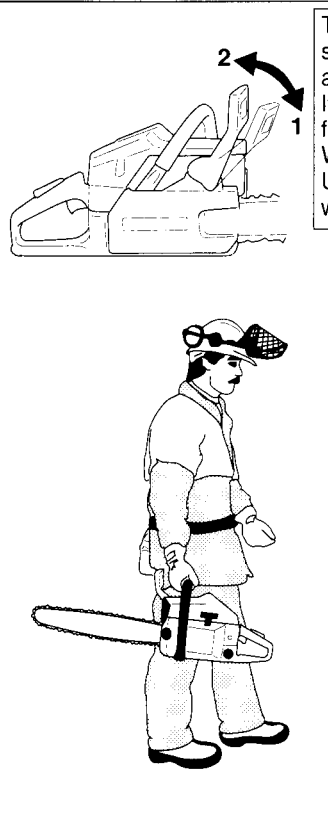

The saw is equipped with a chain brake. The brake is designed to stop the chain immediately in the event of a kick-back. The brake activates when the hand guard is pushed forward (1). If the brake is already activated, it is disengaged by pulling the front hand guard back towards the front handle (2). When working with the saw, the chain brake must be disengaged. Use the chain brake as a "parking brake", if you move the saw with the engine running.

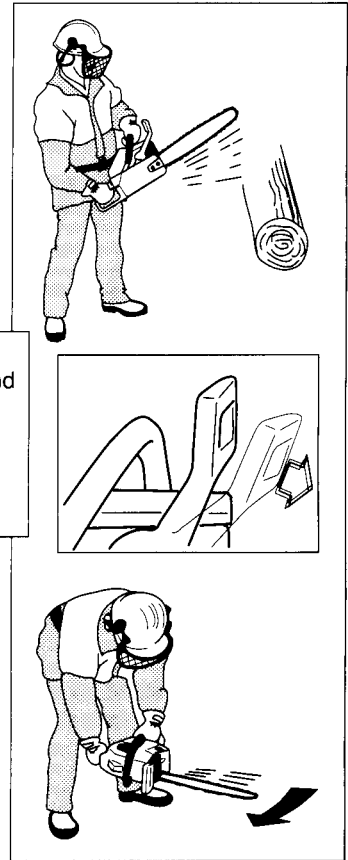

## Inertia activated chain brake

The inertia activated chain brake is activated when the front hand guard is pushed forward, either manually or by a weight in the hand guard. The advantage of the inertia brake is that the brake is activated after kick-back, even if the user's left hand does not contact the hand guard, i.e., also when the saw is in the felling position.

## Control and maintenance of the chain brake

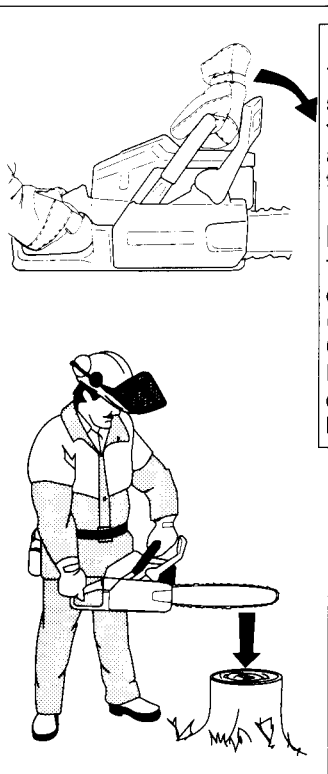

### Braking function control:

The chain brake must be checked several times daily. Place the saw on firm ground. Hold the handles with both hands and apply full throttle. Activate the chain brake by turning your left wrist against the hand guard, without releasing your grip around the front handle. The chain should stop immediately (illustr.).

### Inertia activating function control

The chain brake must be checked several times daily. Hold the chain saw approx. 35 cm (14") above a trunk or other firm object (illustr.).

**CAUTION!** The engine must be shut off. Release your grip around the front handle and let the saw by its own weight rotate around the rear handle. When the tip of the bar hits the trunk, the brake should activate.

### Maintenance:

**⚠ WARNING!** Dirt and wear affect the function of the brake. Follow all maintenance instructions, carefully. If anything is incorrect with your chain brake contact your servicing dealer.

With the engine shut off, the hand guard can be moved back and forth, to ensure that the mechanism works freely and also that the brake activates. If necessary, clean the brake from resin and chips. Lubricate the mechanism and bearing surfaces with oil. Check that the brake band is at least 0.65 mm (.026 in) thick, at the most worn part.

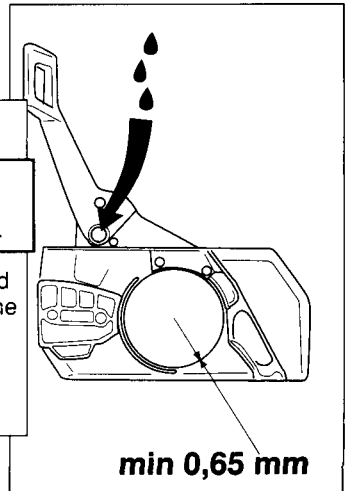

min 0,65 mm

# Maintenance and function

## Air filter

The air filter must be regularly cleaned from dust and dirt in order to avoid:

- Carburettor malfunctions
- Starting problems
- Engine power reduction
- Unnecessary wear on the engine parts
- Abnormal fuel consumption
- Harmful emissions

Clean the air filter daily or more often if the air is exceptionally dusty in the working area. Disassemble the air filter by removing the cylinder cover and unscrew the filter. When reassembling, make sure that the filter is tight against the filter holder. Clean the filter by brushing or shaking it. A more thorough cleaning of the filter is obtained by washing it in water and soap.

Do not use gasoline or any other flammable liquid to clean the filter; doing so can create a fire hazard and produce harmful evaporative emissions.

An air filter, which is used for some time, cannot be cleaned completely. Therefore it must be replaced by a new one, with regular intervals.

**IMPORTANT!** A damaged air filter must always be replaced.

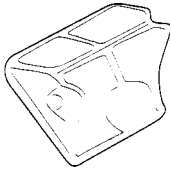
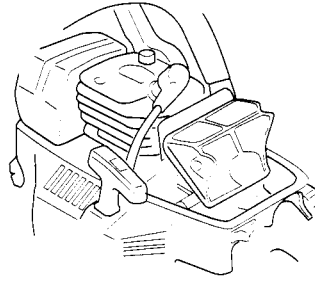

## Muffler

The muffler is designed in order to reduce the noise level and to direct the exhaust gases away from the operator. The exhaust gases are hot and can contain sparks, which may cause fire if directed against dry and combustible material. Some mufflers are equipped with a special screen. If your saw has this type of muffler, you should clean the screen at least once a week. This is done with a wire brush. **The screen must be replaced, if damaged.** The saw will be overheated, if the screen is clogged.

This results in damage on the cylinder and the piston.

**CAUTION!** Never use a saw with a clogged or defective muffler.

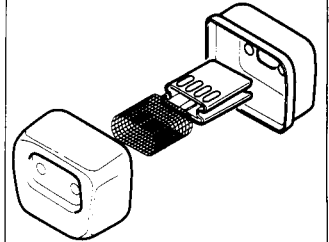

0,5 mm

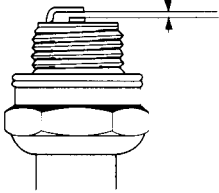

## Spark plug

The spark plug condition is influenced by:

- An incorrect carburettor setting.
- Wrong fuel mixture (too much oil in the gasoline).
- A dirty air filter.

These factors cause deposits on the spark plug electrodes, which may result in malfunction and starting difficulties. **If the engine is low on power, difficult to start or runs poorly at idling speed, always check the spark plug first.** If the spark plug is dirty, clean it and check the electrode gap. Readjust if necessary. The correct gap is 0.5 mm (.020"). The spark plug should be replaced yearly, or earlier if the electrodes are badly eroded.

**IMPORTANT!** Always use the recommended spark plug type. Wrong type may ruin the piston/cylinder.

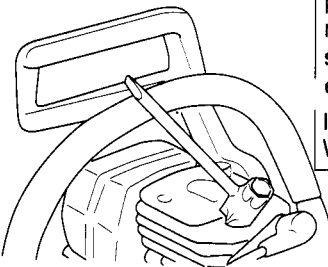

## Clutch drum/chain sprocket

The clutch drum is equipped with one of the following chain sprockets:

- Spur sprocket (A) (the chain sprocket is welded on the drum)
- Rim sprocket (B) (exchangeable)

Both versions have built-in needle bearing at the drive shaft, which has to be greased regularly (once a week).

**NOTE!** Use only high quality bearing grease.

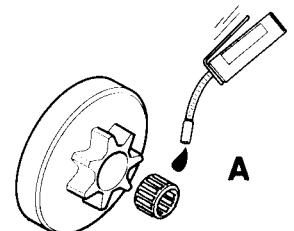
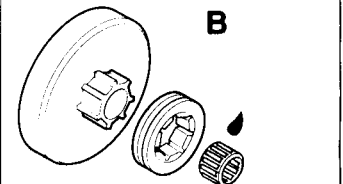

# Starter device

**⚠ WARNING!**

- When the recoil spring is assembled in the starter housing, it is in tensioned position and can when treated carelessly, pop out and cause injuries.
- Always be careful, when changing the recoil spring or the starter cord. Always wear safety goggles for eye protection.

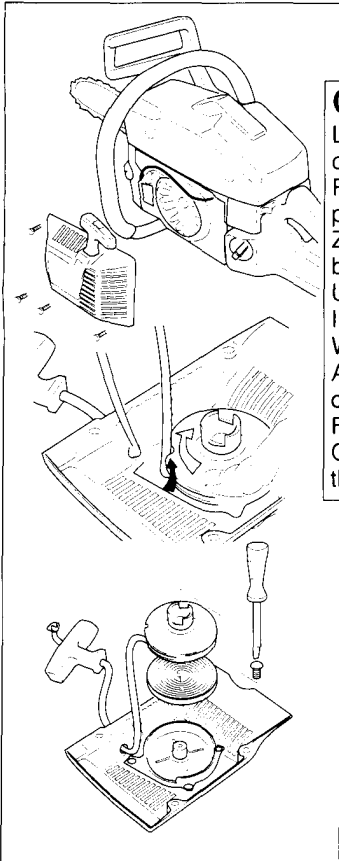

**Changing a broken or worn starter cord**

Loosen the screws, that hold the starter device against the crankcase and remove the starter device.  
Pull out the cord approx. 30 cm and lift it up into the notch in the pulley.  
Zero-set the recoil spring by letting the pulley rotate slowly backwards.  
Undo the screw in the centre of the pulley and remove the pulley.  
Insert and fasten a new starter cord in the pulley.  
Wind approx. 4 turns of the starter cord on to the pulley.  
Assemble the starter pulley against the recoil spring, so the end of the spring engages to the pulley.  
Fit the screw in the centre of the pulley.  
Carry the starter cord through the hole in the starter housing and the starter handle. Make a knot on the starter cord.

**Tensioning the recoil spring**

Lift the starter cord up in the notch on the starter pulley and turn the starter pulley 2 turns clockwise.  
**NOTE!** Check that the starter pulley can be turned at least half a turn, when the starter cord is entirely pulled out.

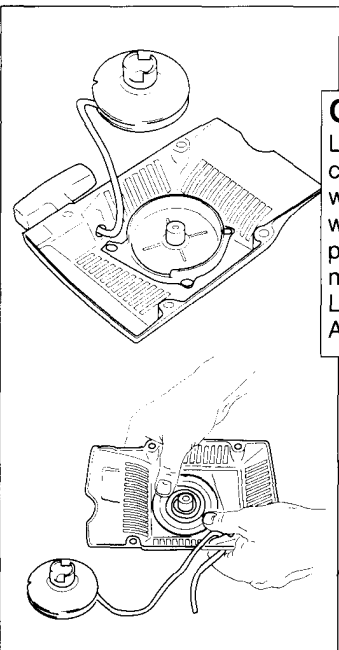
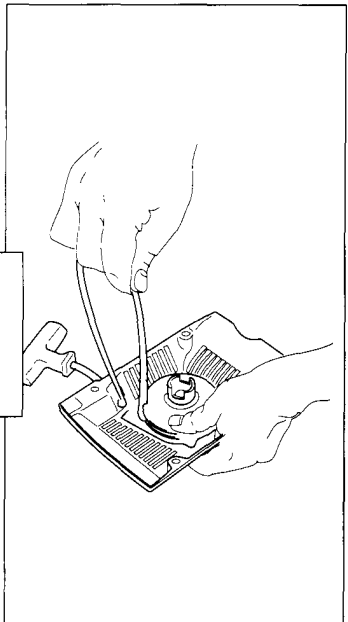

**Changing the broken recoil spring**

Lift the starter pulley. (See, Changing a broken or worn starter cord). The recoil spring is disassembled from the starter device, with its inside facing down. Tap the starter lightly against a working bench or similar. Put a new recoil spring in the right position. If the spring pops out when assembling, it should be mounted again, out and in towards the centre.  
Lubricate the recoil spring with thin oil.  
Assemble the starter pulley, and tension the recoil spring.

**Starter device assembly**

Assemble the starter device, by pulling the starter cord out first, then place the starter against the crankcase. Then slowly release the starter cord so that the pulley engages with the pawls.  
Assemble and tighten the screws, which hold the starter.

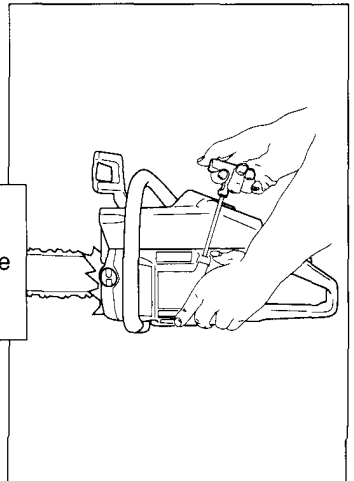

# Chain maintenance

## Chain maintenance - safety

For the personal safety, it is of great importance, that the bar and chain combinations of so called low kick type are used and that the cutting equipment is maintained correctly.

Important notes:

- Chain tension
- Sharpening
- Lubrication
- Check - maintenance

## Recommended cutting equipment for Husqvarna chain saws

Following is a list of recommended cutting equipment for saws below 3.8 cu. in. (62,3 cc) cylinder displacement. The combinations of powerhead, bar and chain have been investigated in accordance with the kickback requirements of ANSI B 175.1.

The guide bar nose radius is determined by either the maximum number of teeth in the nose sprocket or the corresponding maximum nose radius of a solid bar.

The following list is the chain saw manufacturers recommendations. There may be other combinations available, which will also achieve kickback protection.

As we are listing the maximum guide bar nose radius, you may use a guide bar with smaller nose radius than in our list. For guide bars of the same length, all sprocket-nose guide bars of the same pitch and having the same number of sprocket teeth may be considered to have equivalent kickback energy. A hard nose bar having the same length and nose radius as a sprocket-nose bar may be considered to have equivalent or less kickback energy than the sprocket-nose bar.

Low kickback saw chain is a chain which has met the kickback performance requirements of ANSI B 175.1 safety requirements for gasoline-powered chainsaws when tested on the representative sample of chain saws below 3.8 cu.in. specified in ANSI B 175.1 These are marked with an asterisk \* in the table below. We recommend that you as replacement use the listed chains or "Low kickback saw chains" which are available at your dealer.

NOTE: The second number in the Oregon part number indicate the thickness of the drive link. You are free to choose between 0.050" and 0.058" drive link for the corresponding bar.

HUSQVARNA H30 and OREGON 33 indicates 0.050"/1.3 mm

OREGON 34 indicates 0.058"/1.5 mm

Saw Chain	Length inch	Pitch inch	Max nose radius
Husqvarna H30	15, 16, & 18	.325	10t
Oregon 91SG *	14 & 16	3/8	9t
Oregon 34SL *	16 & 18	.325	10t
Oregon 34LG *	16 & 18	.325	10t

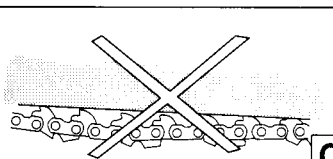

## Chain tension

A too loose chain may jump off the bar and cause injuries. This is also the most frequent cause of chain problems. A too loose chain can also ruin the chain, bar and drive sprocket. Chain tension should be checked frequently during work and corrected if necessary.

**⚠ WARNING!** Make sure that the engine is shut off.

**Tension the chain as tight as possible, but so it can still be pulled easily along the bar by hand.**

**CAUTION!** Check after tensioning by pulling the chain in the normal direction of rotation. Always wear gloves to protect your hands from injury.

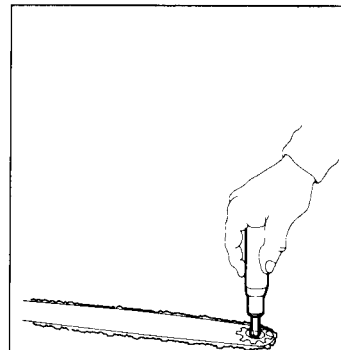

## Chain lubrication

Fill up the chain oil tank with chain oil each time you fuel. Never run the chain dry. Insufficient oil may cause friction which leads to cracks in the links. Waste oil must be avoided for the same reason. Always use a proper chain oil which is off the non-flying type and stands the pressure of the cutters. Bars provided with nose sprockets are to be lubricated when refilling. Clean bar groove and oil filling hole regularly.

## Checking the lubrication

Direct the nose of the guide bar against a bright object, at a distance of abt 20 cm (8"). Run the saw at 3/4 full throttle for 1/2-1 minute and check that there is oil sprayed on the object.

## Check daily for:

- Cracks in rivets and links of the chain.
- Excessive wear on side links and cutters or stiffness in the chain.
- A cutter should never be filed to less than 5/32 inch or 4 mm.
- Correct depth gauge setting.

**NOTE!** Change the drive sprocket each time you fit a new chain.

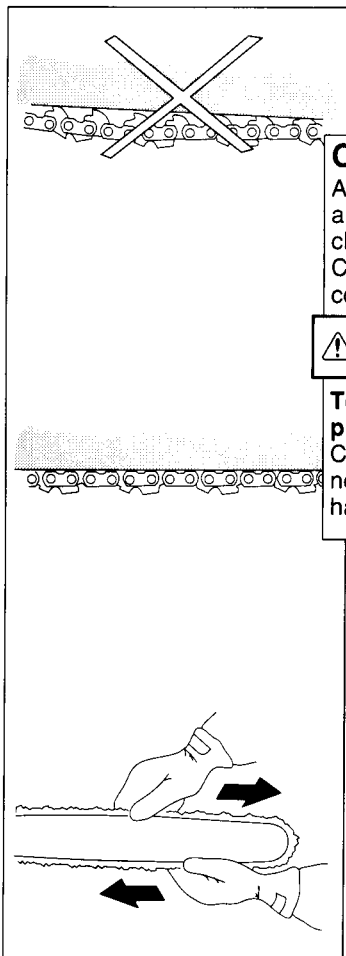

# Chain maintenance

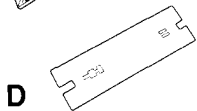
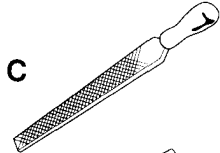
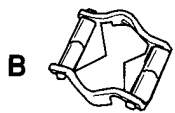
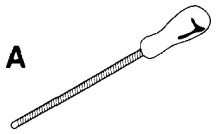

## Sharpening

Never cut with a dull saw chain. A chain which does not cut unless you press it hard against the wood is damaged, dull or incorrectly filed. In order to file the chain correctly you need: round file (A), file gauge (B), flat file (C) and a depth gauge tool (D). By using the correct file size (see the table) and an file gauge with a marked filing angle, it is easier to receive a good result. NOTE! Check that the drive link does not have a too large play in the bar groove. This can give an incorrect filing result. Always file from the inside of the teeth and out. Then turn the saw and file on the other side. In order to receive a straight cut in the wood, all the teeth should be filed to the same length. If the chain is filed regularly, only a few strokes are needed on every saw tooth. For the best performance, every chain type has different cutting angles, file sizes and filing depth (see the table).

**⚠ WARNING!** If a too small filing size is used or the file is kept too deep in the cutting tooth, the chain will be dangerously aggressive. This means that kick-back can occur.

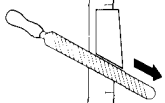
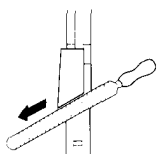
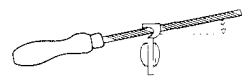
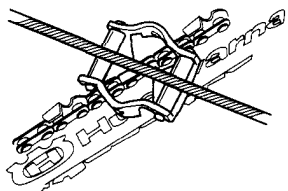

## Depth gauge

In order to receive the best performance and life time of the chain, always keep the prescribed depth gauge setting.

**⚠ WARNING!** A too big depth gauge makes the chain dangerously aggressive. This means that kickback can occur.

The depth gauge of the cutting tooth is checked with a depth gauge tool (measurement, see table).

NOTE! The chain should be filed before the depth gauge is checked. An adjustment of the depth gauge is done with a flat file. Round off the corner of the depth gauge, afterwards.

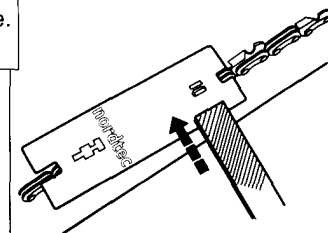
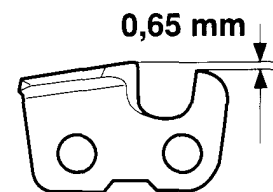
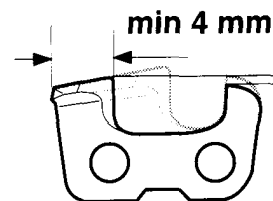
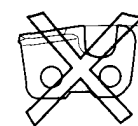
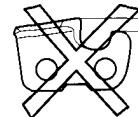
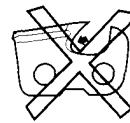
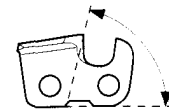

	inch	inch/mm	inch/mm				inch/mm	inch/cm/dl
34SL/LG	.325	0.058/1,5	/4,5	60°	25°	0°	.025/0,65	16/41/66 18/46/72
H30	.325	0.050/1,3	3/16/4,8	85°	30°	10°	.025/0,65	15/38/64 16/41/66 18/46/72
H30	.325	0.050/1,3	3/16/4,8	85°	30°	10°	.025/0,65	16/41/66 18/46/72
91SG	3/8	0.050/1,3	5/32/4,5	85°	30°	0°	.025/0,65	14/35/52 16/39/56

# Maintenance

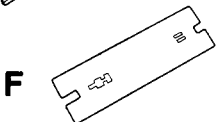
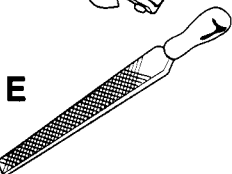
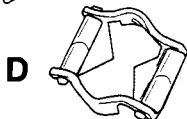
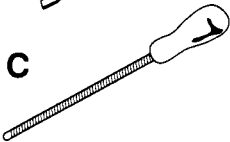
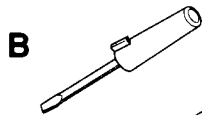
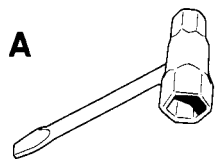

## Tools and materials

The tools and material shown are absolutely essential for routine everyday safe operation and maintenance of a chain saw.

**T-wrench (A)** – This type of wrench or its equivalent should always be carried with your chain saw. The wrench is needed to adjust chain tension which must be correctly adjusted for safer cutting.

**Small screwdriver (B)** – Used for carburetor adjustment.

**Files** - You need one round file (C) with file gauge (D) to sharpen the cutting teeth of the chain and one flat file (E) and depth gauge tool (F) for filing the depth gauge.

## Winter use

During winter time, powder snow and cold weather can cause running problems, such as:

- Too low engine temperature.
- Icing on the air filter and carburettor.

**Air filter "MEDIUM MESH" must be used.**

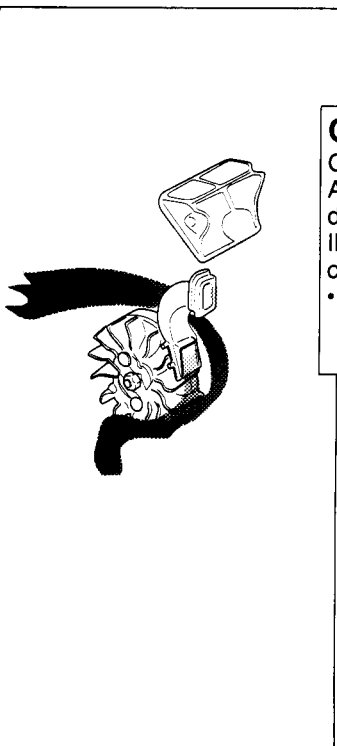
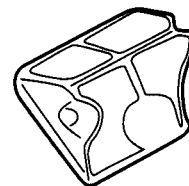

## Centrifugal cleaning

Centrifugal cleaning means the following:

All air to the carburettor is carried through the starter. Dirt and dust is centrifuged away by the cooling fan.

**IMPORTANT!** In order to keep the function of the centrifugal cleaning, a continuous maintenance and care must be made.

- Clean the air intake to the starter, the fan wings of the flywheel, the space around the flywheel, inlet pipe and carburettor space.

# Maintenance

Below you will find some general maintenance instructions.  
If you have more questions, contact your servicing dealer.

Use only genuine Husqvarna replacement parts.

## Daily maintenance:

1. Check the throttle trigger for smooth operation. If any binding occurs, or if engine fails to return to idle, the saw should be taken to your dealer, before it is used again. Also, be sure that the trigger cannot be pulled until the throttle trigger lockout is depressed.
2. Clean the chain brake and check its function according to the instructions. Make sure that the chain catcher is undamaged. Otherwise replace it immediately.
3. Clean or replace the air filter as necessary. Check for damage or holes.
4. The bar should be turned daily for more even wear. Check the lubrication hole in the bar, to be sure it is not clogged. Clean the bar groove, if the bar has a sprocket tip, this should be lubricated.
5. Check the function of the oiler to be sure the bar and chain receive proper lubrication.
6. Sharpen the chain and check its tension and condition. Check the drive sprocket for wear. Replace if necessary.
7. Check the starter and starter cord for wear or damage. Clean the air intake slots on the starter housing.
8. Check for any loose nuts and screws and retighten if necessary.
9. Test the stop switch to be sure it shuts off the engine.

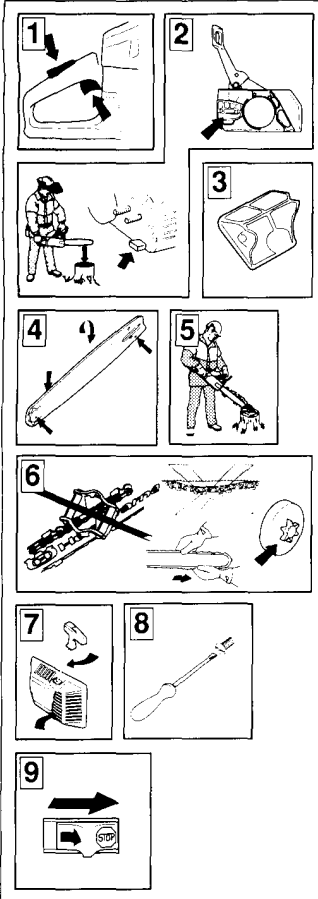

## Weekly maintenance:

10. Check that the AV elements are not soft or torn.
11. Lubricate the clutch drum bearing.
12. File off burrs, if any, on the sides of the bar.
13. Clean the spark plug and check the gap. The correct gap is 0.5 mm (.020 in).
14. Check the starter and the recoil spring. Clean the fins on the flywheel.
15. Clean the cooling fins on the cylinder.
16. Clean or change the screen in the muffler.
17. Clean the carburettor body and air box.

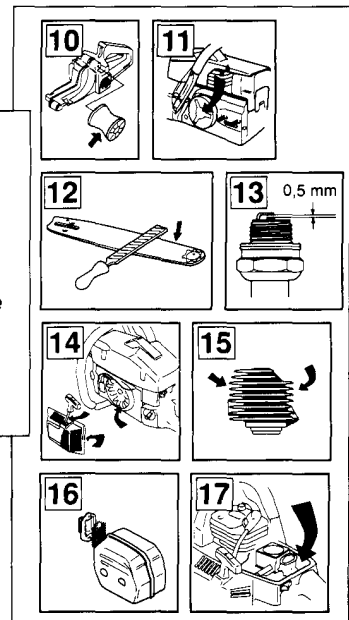

## Monthly maintenance:

18. Check the brake band on the chain brake for wear.
19. Check the clutch centre, clutch drum and clutch spring for wear.
20. Clean the outside of the carburettor.
21. Check the fuel filter. Change if necessary.
22. Flush the inside of the fuel tank with gasoline.
23. Flush the inside of the oil tank with gasoline.
24. Check all cables and connections.



# Carburettor

## Functioning, Basic setting, Final setting

**⚠ WARNING!** Do not start the saw without the bar, chain and clutch cover (chain brake) assembled. If you do, the clutch might come loose and cause severe injuries.

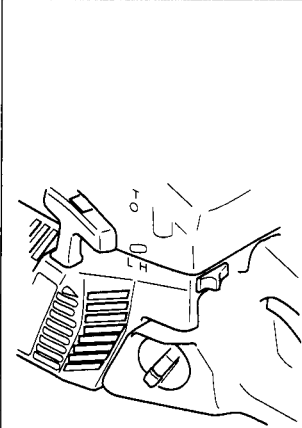

### Functioning

- The carburettor governs the engine speed via the throttle trigger. In the carburettor, air/fuel is mixed. This air/fuel mixture is adjustable. If you want to take advantage of the maximum output of the engine, the setting must be correct.
- The setting of the carburettor means that the engine is adjusted to local conditions, for example climate, altitude, petrol and type of two-stroke oil.
- The carburettor has three adjustment possibilities:  
L=Low speed needle  
H=High speed needle  
T=Idle speed adjustment screw
- The fuel quantity required in proportion to the airflow the throttle trigger level allows is adjusted by means of the L- and H-needles. Turning the needles clockwise gives a leaner fuel mixture (less fuel), turning them counter-clockwise gives a richer fuel mixture (more fuel). A lean mixture gives higher rpm:s and a rich one lower rpm:s.

**NOTE:** Your unit is equipped with limiter caps, do not attempt to adjust the needles beyond the stop as damage can occur.

- The idling speed screw T regulates the position of the throttle lever in the idling speed position. Turn the idling speed screw clockwise gives a higher idling speed, turn it counter-clockwise a lower idling speed.

### Basic setting

- The carburettor is adjusted to a basic setting when the saw is tested at the factory. The basic setting is richer than the optimum setting and shall be maintained during the first working hours. Thereafter, do the final setting of the carburettor. The basic setting can vary between: H=2-1/8 to 2-7/8 turn respectively L=1-1/2 to 2-1/4 turn.

**NOTE!** If the chain rotates in the idling position, turn the idling speed screw counter-clockwise until the chain stops.

### Final setting

- After the "break in" period (about 5 hours), the final setting is to be done. This setting is done to ensure that your unit is running at peak performance and producing the least amount of harmful emissions. **Have the final setting done by qualified service personnel.** This service is not covered by warranty.

First, adjust the low speed needle L, then the high speed needle H, and finally the idling speed screw T. The carburettor should be set according to the following RPM limits:

Max. speed (no load)=13,000 rpm  
Idling speed=2800/3200 rpm

### Conditions

- Before all settings are done the air filter must be clean and the cylinder cover mounted.
- Set the needles marked T, L, and H to the mid point of the limiter cap.
- Start the saw according to the starting instructions and warm it up during 10 minutes.

**NOTE!** if the chain rotates in the idling position, turn the idling speed screw counter-clockwise until the chain stops.

- Put the saw on a flat surface, the bar pointing in the opposite direction of you. Avoid that bar and chain get into contact with the surface or other objects.

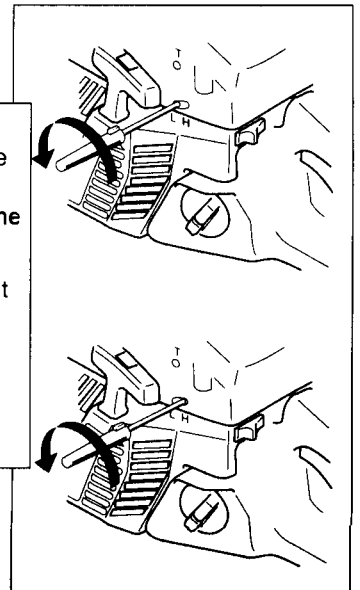



**NOTE!** Do not attempt to adjust the needles beyond the stops as damage can occur.

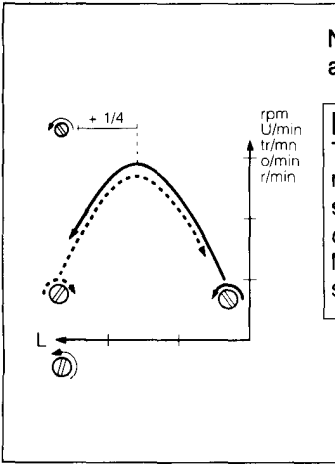

## Low speed needle L

Try to find the highest idling speed by turning the low speed needle L within the limits of the limiter cap. When the highest speed has been found, turn the low speed needle L 1/16 turn counter-clockwise or to the limiter cap stop.

**NOTE!** If the chain rotates in the idling position, turn the idling speed screw counter-clockwise until the chain stops.

## High speed needle H

The high speed needle H influences the power of the saw. A too lean adjusted high speed needle H (high speed needle H closed too much) gives overrevs and damages the engine. Let the saw run at full speed for about 10 seconds. Thereafter, turn the high speed needle H 1/16 turn counter-clockwise. Let the saw run again at full speed for about 10 seconds and note the difference in the engines sound. The high speed needle H is correctly set when the saw "4-cycles" a little. If the saw "whistles" the setting is too lean. If there is too much exhaust gas at the same time as the saw "4 cycles" much, the setting is too rich. Turn the high speed needle H until the setting sounds correct.

If the engine does not operate properly within the limiter cap range, do not use the unit. Take it to your Authorized Service Dealer.

**NOTE!** For optimum setting of the carburettor, contact a qualified servicing dealer who has a revolution counter at his disposal. The maximum speed recommended, 13 000 rpm, must not be exceeded.

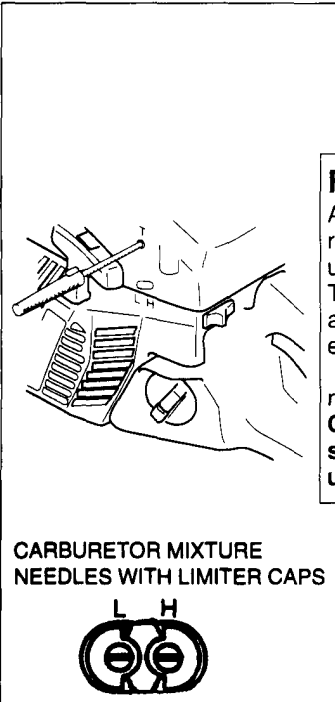
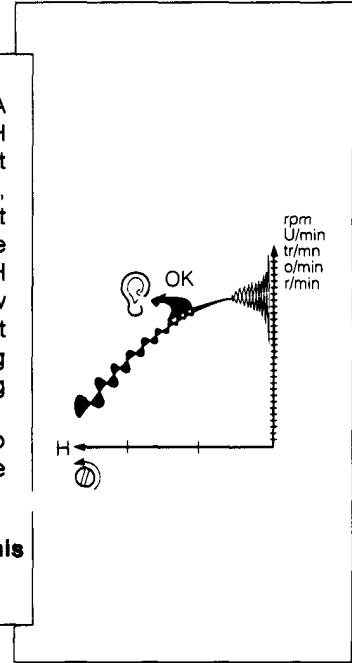

## Final setting of the idling speed T

Adjust the idling speed with the screw T. If it is necessary to readjust, first turn the idle speed adjusting screw T clockwise, until the chain starts to rotate.

Then turn, counter-clockwise until the chain stops. A correctly adjusted idle speed setting (approx. 3 000 rpm) occurs when the engine runs smoothly in every position.

It should also be good margin to the rpm when the chain starts to rotate.

**CAUTION!** contact your servicing dealer, if the idle speed setting cannot be adjusted so that the chain stops. Do not use the saw until it has been properly adjusted or repaired.

## Correctly adjusted carburettor

A correctly adjusted carburettor means that the saw accelerates without hesitation and the saw 4-cycles a little at max speed.

Furthermore, the chain must not rotate at idling. A too lean adjusted low speed needle L may cause starting difficulties and bad acceleration.

A too lean adjusted high speed needle H gives lower power=less capacity, bad acceleration and/or damage to the engine.

A too rich adjustment of the two speed needles L and H gives acceleration problems or too low working speed.

# Equipment needed

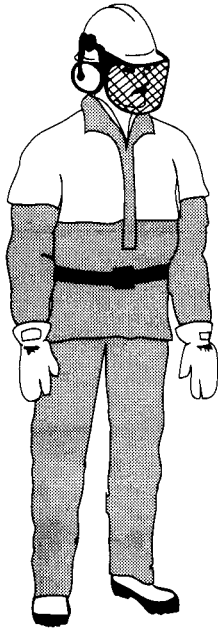

## Clothing

The proper clothing and equipment (as shown) protect you from many potential hazards such as lacerations, thrown objects, and hearing loss.

Always wear:

- safety helmet
- ear protection
- visor or goggles
- heavy-duty non-slip gloves
- safety pants or chaps
- boots with steel toe caps and no-slip soles

## First aid kit

A first aid kit approved by the Red Cross or an organization of similar stature should always be carried in case of injury in the field. A kit should contain large dressings for lacerations, splints and slings for fractures, antiseptic and other optional items for your safety and convenience such as insect repellent.

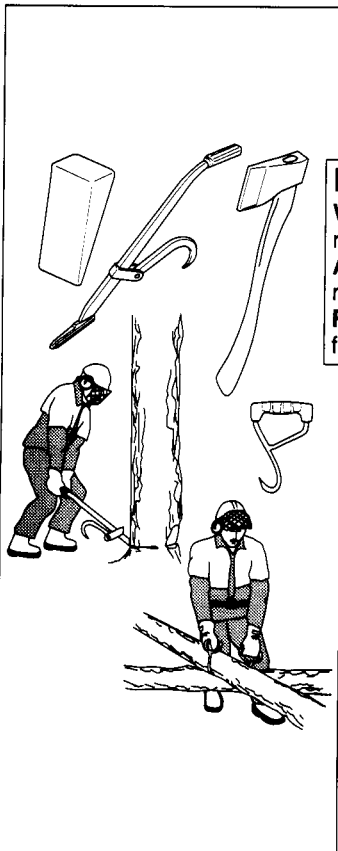
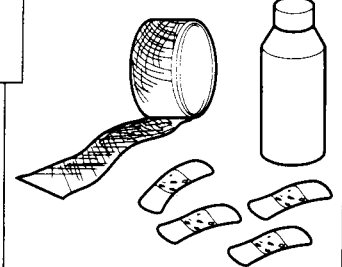

## Forestry tools

**Wedge** – You should carry at least one non-metal wedge to help remove a stuck saw safely.

**Axe** – Useful for trimming and clearing work that is hazardous or not recommended for a chain saw.

**Felling lever and hook** – The felling lever is used to assist in felling a tree, and the hook can be used to move a felled tree.

# General working instruction

## General

Avoid cutting in adverse weather conditions, such as dense fog, heavy rain, high winds, etc. Adverse weather is often tiring to work in and creates potentially dangerous conditions such as slippery ground. High winds may force the tree to fall in an unexpected direction causing property damage or personal injury.

**Never use a chain saw to pry or for any purpose for which it is not intended.**

Avoid stumbling on obstacles such as stumps, roots, rocks, branches and fallen trees. Watch out for holes and ditches. Be extremely cautious when working on slopes or uneven ground. Shut off the saw when moving from one work place to another.

Always cut a wide-open throttle. A slow moving chain can easily catch and force the saw to jerk.

Don't be embarrassed to ask for help if you get into a cutting situation that seems difficult to you. To continue could be dangerous. For example - an obstacle such as power lines, close to the cutting area.

When cutting with the bottom part of the chain the reactive force will pull the saw away from you towards the wood you are cutting.

The saw will control the feeding speed and sawdust will be directed towards you.

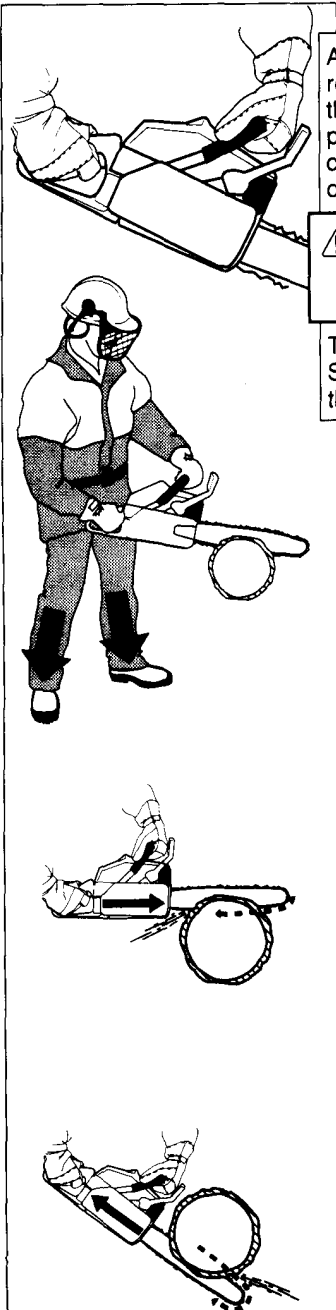

Always keep a firm grip on the saw with your right hand on the rear handle, your left hand on the front handle, and with your thumbs and fingers encircling the handle. With your hands in this position, you can best oppose and absorb reactive forces of your chain saw. Make sure your chain saw handles are in good condition, and free from moisture, oil and grease.

**⚠ WARNING! Never use the saw with only one hand. You cannot control the saw properly and you may lose control and injure yourself severely.**

The safest method is to cut with the bottom part of the chain. Sawing with the upper part makes it much more difficult to control the saw and increase the risk of kickback.

**⚠ WARNING! A majority of kickback accidents occur during limbing. Do not use the nose of the guide bar. Be extremely cautious and avoid contacting the log, other limbs or objects with the nose of the guide bar. Be extremely cautious of limbs under tension. They can spring back towards you and cause loss of control resulting in injury.**

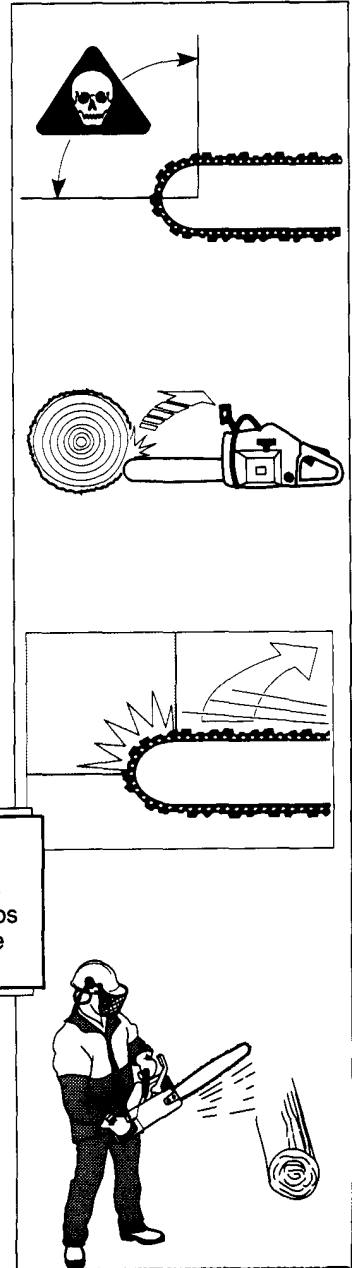

# General working instruction

## Basic rules for felling trees

Normally the felling consists of two main cutting operations - notching and making the felling cut.

### Notching

Start making the upper notch cut on the side of the tree facing the felling direction.

Look through the kerf as you saw the lower cut so you do not saw too deep into the trunk.

The notch should be deep enough to create a hinge of sufficient width and strength. The notch opening should be wide enough to direct the fall of the tree as long as possible.

### Felling cut

Saw the felling cut from the other side of the tree and (3-5 cm) above the edge of the notch. Never saw completely through the trunk. Always leave a hinge. The hinge guides the tree. If the trunk is completely cut through, you lose control over the felling direction.

Insert a wedge or a felling lever in the cut well before the tree becomes unstable and starts to move. This will prevent the guidebar from binding in the felling cut if you have misjudged the falling direction. Make sure no people have come into the range of the falling tree before you push it over.

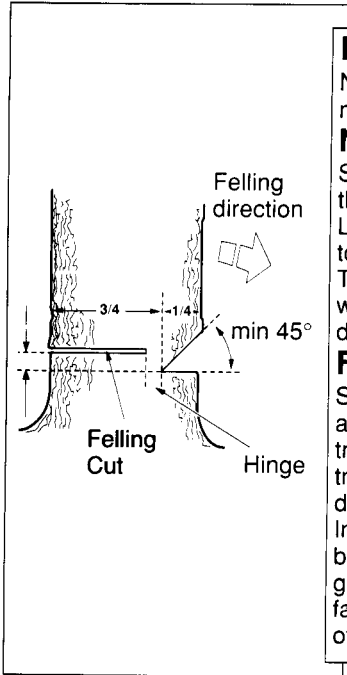

## Felling cut, trunk diameter less than guide bar length

Saw either with a pushing chain (top of guide bar) ... or with a pulling chain (bottom of guide bar).

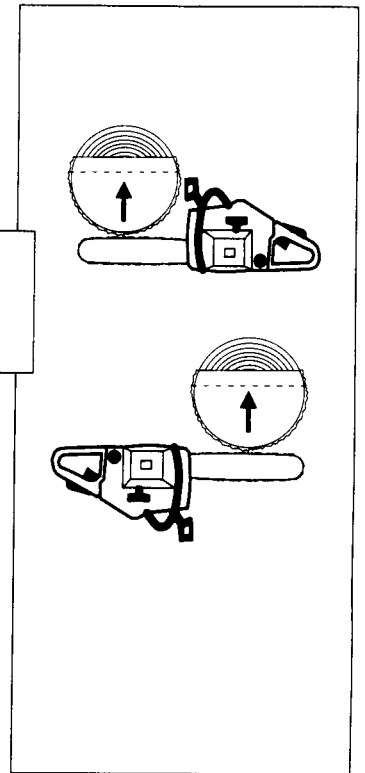

## Felling cut, trunk diameter greater than guide bar length

Make a boring cut. Watch out for kickbacks. Do not use the upper tip quadrant of the guide bar tip.

Saw with a pushing chain. Leave a sufficient hinge.

Complete the felling cut by sawing around the trunk with a pulling chain.

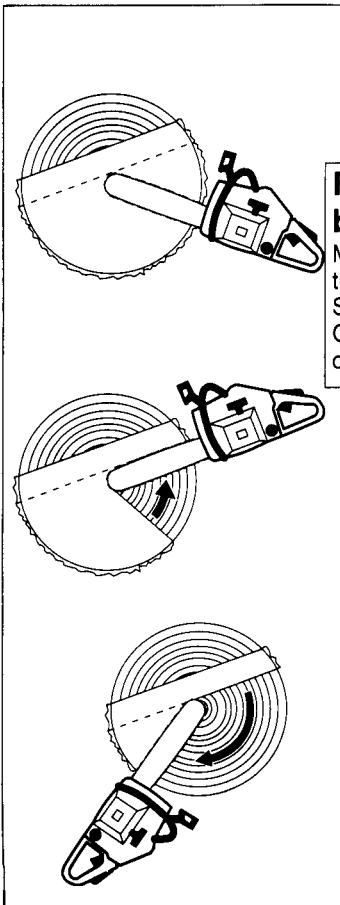

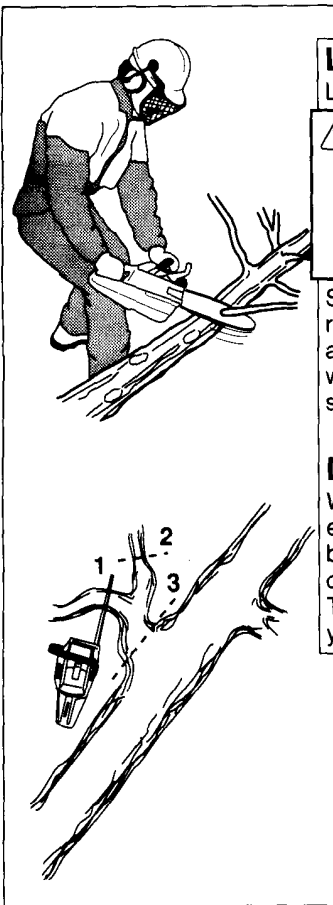

## Limbing

Limbing is removing the branches from a felled tree.

**⚠ WARNING!** A majority of kickback accidents occur during limbing. Do not use the nose of the guide bar. Be extremely cautious and avoid contacting the log, other limbs or objects with the nose of the guide bar. Be extremely cautious of limbs under tension. They can spring back towards you and cause loss of control resulting in injury.

Stand on the left side of the trunk. Maintain a secure footing and rest the saw on the trunk. Hold the saw close to you so that you are in full control of it. Keep well away from the chain. Move only when the trunk is between you and the chain. Watch out for spring back of limbs under tension.

## Limbing thick branches

When limbing thick branches, the guide bar may get pinched easily. Branches under tension often snap up, so cut troublesome branches in small steps. Apply the same principles as for cross cutting.

Think ahead and be aware of the possible consequences of all your actions.

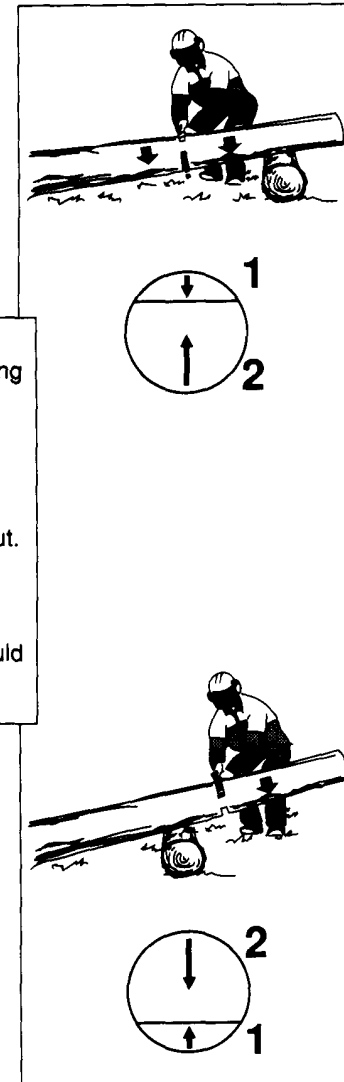

## Cross cutting/bucking

Before starting to cut through the log, try to imagine what is going to happen. Look out for stresses in the log and cut through in such a manner that the guide bar will not get pinched.

## Cross cutting logs, pressure on top

Firm stance. Begin with an upper cut. Do not cut too deeply - about 1/3 of the log diameter is enough. Finish with a bottom cut. The saw cuts should meet.

## Cross cutting logs, pressure on bottom

Firm stance. Begin with a bottom cut. The depth of the cut should be about 1/3 of the log diameter. Finish with an upper cut. The saw cuts should meet.

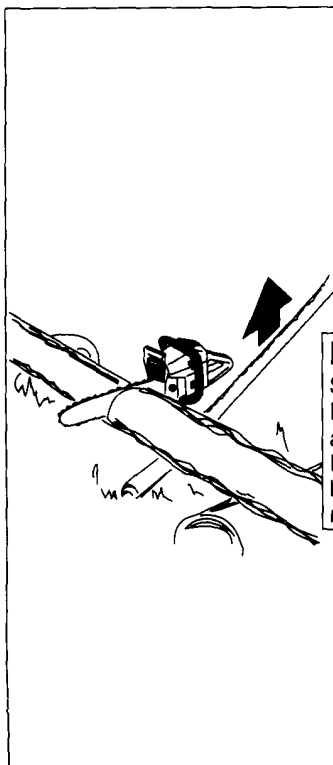

## If the saw gets stuck

Stop the engine.

Raise the log or change its position, using a thick branch or pole as a lever.

Do not try to pull the saw free. If you do, you can deform the handle or be injured by the saw chain if the saw is suddenly released.

**Common sense**

We have already pointed out that a chain saw is a dangerous tool, if used carelessly, or if improperly maintained. If you use your chain saw as intended, it is an excellent tool. Should you lack information in any respect, should you feel uncertain about anything, please contact us or one of our servicing dealers. Feel free to visit our servicing dealers at any time. They will give you continuous information about new features on our saws, safety devices, new products, new accessories, etc.

