

 Husqvarna

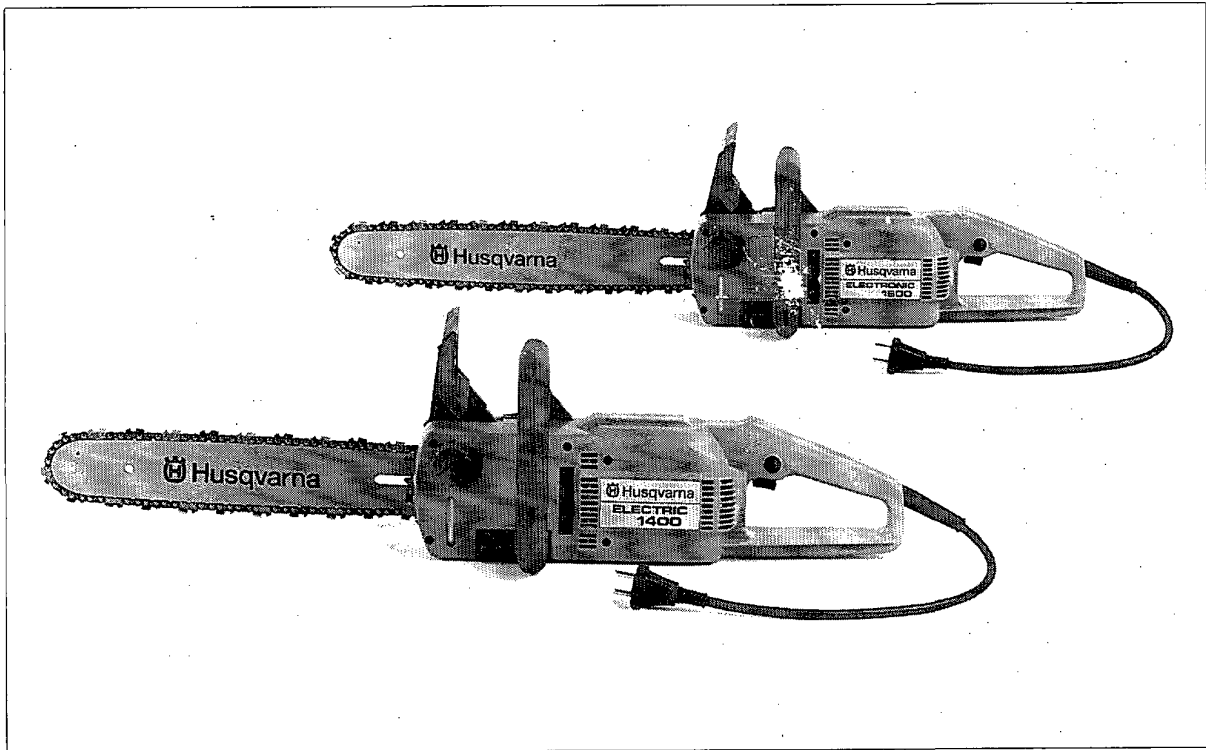

Electric 1400 Electronic 1600

Operator's Manual
Manuale do utilizador
Manual del operador
Οδηγίες χρήσεως

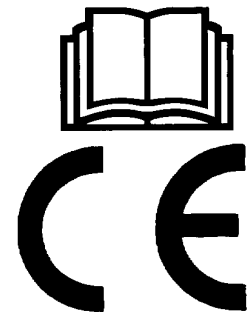

1018772-

1400 Electric
1600 Electronic

Symbols explanation

Symbols on the chainsaw:



WARNING! The chainsaw can be dangerous!
Careless or improper use can cause serious or even fatal injury



Read and Understand the Operator's Manual before using the chainsaw.



Always wear:

- safety helmet
- ear protection
- visor or goggles



Must not be subject to rain or damp.

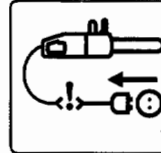

Unplug immediately if cable is damaged.

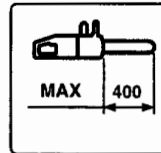

Maximum permissible bar length.

Symbols in the instruction manual:

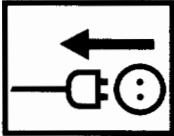

WARNING! Always pull out the plug before fitting parts or adjusting the saw.

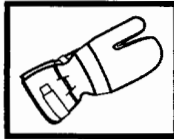

Always wear safety gloves.

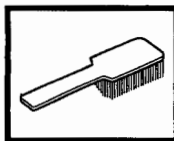

Regular cleaning is required.

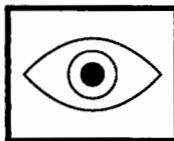

Visual check.



Safety glasses or a visor must be worn.

CONTENTS

Before using a new saw

- Read the instructions carefully.
- Check cutting equipment is correctly fitted and adjusted. See page 23.
- Start the saw and check the carburettor setting. See pages 24.
- Do not use the saw until sufficient chain oil has reached the chain, see page 13.

IMPORTANT!

If the chain is badly adjusted it will cause increased wear or damage to the bar, drive sprocket and chain.



Under no circumstances should you modify the original design of the chain saw without approval from the manufacturer. Always use genuine spare parts. Unauthorised modifications or accessories may lead to serious injury or death.

Contents

Key to symbols	2
Safety instructions	
Personal safety equipment	4
Chain saw safety equipment	4
Inspecting, maintaining and servicing chain saw safety equipment.....	7
Cutting equipment	9
How to avoid kickback	15
General safety precautions	16
General working instructions	17
What is what?	
What is what?	22
Assembly	
Mounting guide bar and chain	23
Start and stop	
Start and stop	24
Maintenance	
Daily maintenance:	25
Technical data	
1400W	26
1600W	26

SAFETY INSTRUCTIONS



A chain saw is a dangerous tool if used carelessly or incorrectly and can cause serious, even fatal injuries. It is very important that you read and understand these instructions.

PERSONAL SAFETY EQUIPMENT



MOST CHAIN SAW ACCIDENTS HAPPEN WHEN THE CHAIN TOUCHES THE OPERATOR. You must wear approved safety equipment whenever you use a chain saw. Personal safety equipment cannot eliminate the risk of injury but it will reduce the degree of injury if an accident does happen. Ask your chain saw dealer for help in choosing the right equipment.

- SAFETY HELMET
- HEARING PROTECTION
- SAFETY GLASSES OR VISOR

- GLOVES WITH SAW PROTECTION

- SAFETY TROUSERS WITH SAW PROTECTION

- BOOTS WITH SAW PROTECTION, STEEL TOE-CAP AND NON-SLIP SOLE

Generally clothes should be close-fitting without restricting your freedom of movement.

- ALWAYS HAVE A FIRST AID KIT NEARBY

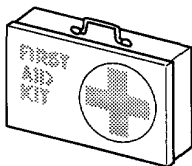
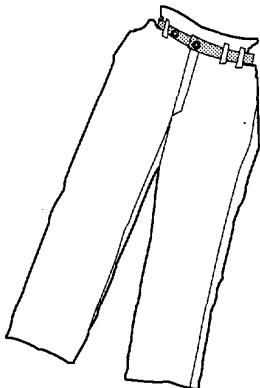
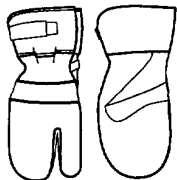

CHAIN SAW SAFETY EQUIPMENT

This section explains the various safety features of the saw, how they work, and basic inspection and maintenance you should carry out to ensure safe operation. (See the "What is what?" section to find out where these components are on Your saw).



NEVER USE A CHAIN SAW THAT HAS FAULTY SAFETY EQUIPMENT! Carry out the inspection, maintenance and service routines listed in this section.

- 1 Chain brake and safety trigger

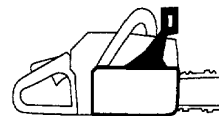

- 2 Power trigger lockout

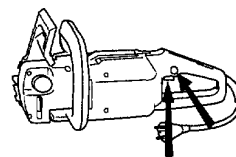

- 3 Chain catcher

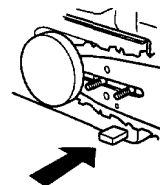

- 4 Right hand guard

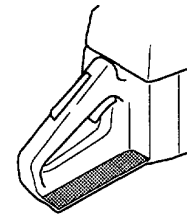

- 5 Sliding clutch

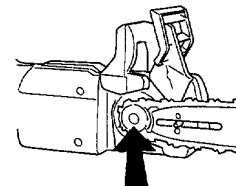

- 6 Cutting equipment (see "Cutting equipment" section).

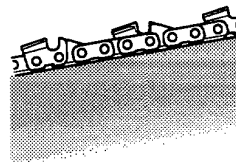

SAFETY INSTRUCTIONS

1 Chain brake and safety trigger

YOUR chain saw is equipped with a chain brake that is designed to stop the chain immediately if you get a kickback. The chain brake reduces the risk of accidents, but only you can prevent them.

Take care when using your saw and make sure the kickback zone of the bar never touches any object.

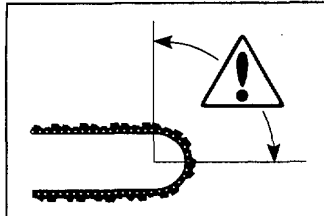

- 1 The chain brake (A) can either be activated manually (by your left hand) or automatically by the inertia release mechanism (a free-swinging pendulum). On most of our models the safety trigger acts as a counterweight in case of kickback.

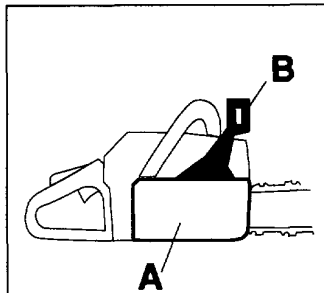

The brake is applied when the Safety Trigger (B) is pushed forwards.

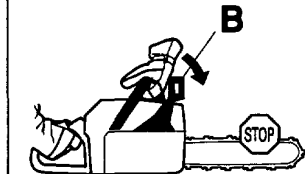

This movement activates a spring-loaded mechanism that tightens the Brake Band (C) around the engine drive system (D) (Clutch Drum).

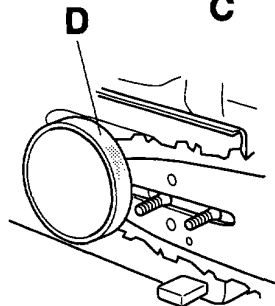
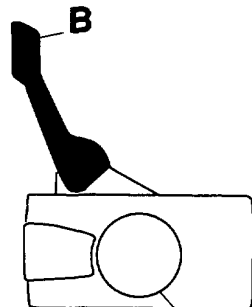

- 2 The safety trigger is designed solely to activate the chain brake. Another important safety feature is that it prevents the chain from hitting your left hand if you lose your grip on the front handle.

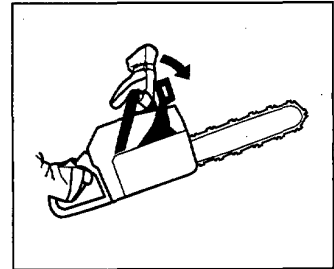

- 3 You can also use the chain brake as a temporary brake when you change position or if you put the saw down for a short time. You should also apply the chain brake manually if there is a risk of the chain accidentally hitting anyone or anything close by.

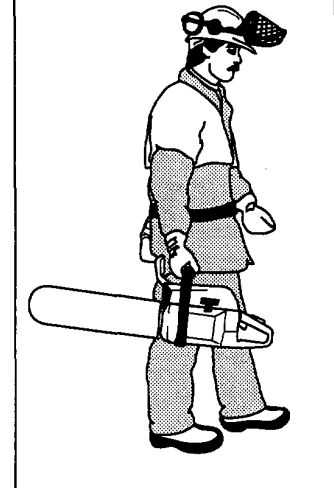
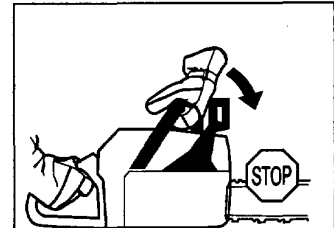

- 4 To release the chain brake pull the safety trigger backwards, towards the front handle.

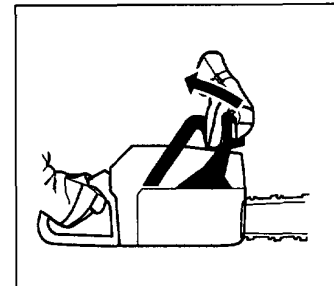

- 5 As mentioned in section A, kickback can be very sudden and violent. Most kickbacks are minor and do not always activate the chain brake. If this happens you should hold the chain saw firmly and not let go.

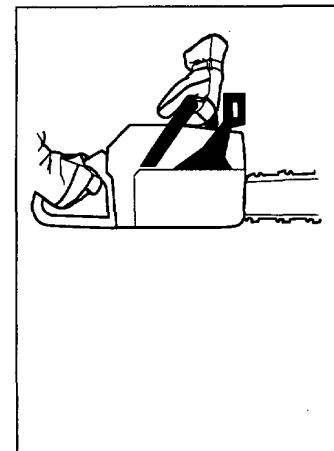

SAFETY INSTRUCTIONS

- 6 The way the chain brake is triggered, either manually or automatically, depends on the force of the kickback and the position of the chain saw in relation to the object that the kickback zone of the bar strikes.

If you get a violent kickback while the kickback zone of the bar is farthest away from you the chain brake will be activated by the movement of the counterweight (INERTIA ACTIVATED).

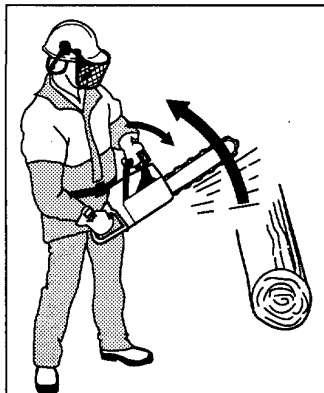

If the kickback is less violent or the kickback zone of the bar is closer to you the chain brake will be activated manually by the movement of your left hand.

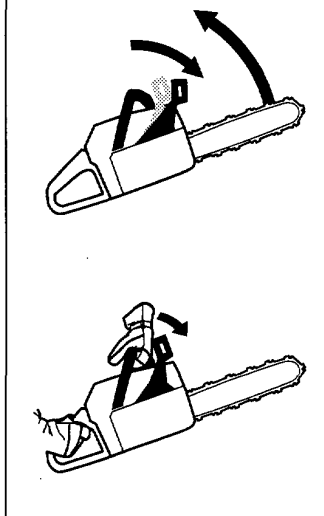

- 7 During felling your left hand grasps the front handle in such a way that it cannot activate the safety trigger. In this position the chain brake can only be activated by the inertia action of the counterweight.

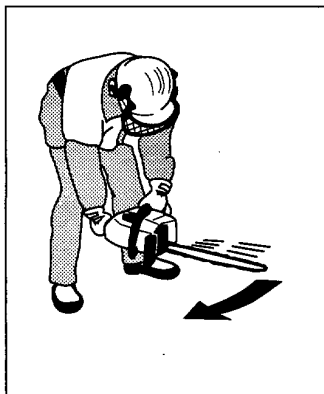

The inertia activated chain brake increases your safety but there are certain factors to remember (see point 6 above).

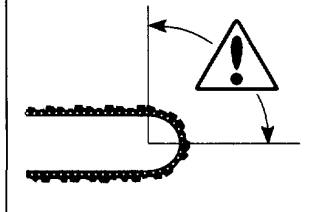

2 Power trigger lockout

Grasp the front handle with your left hand. Grasp the rear handle with your right hand. Push in the lock button using your right thumb and press the start button.

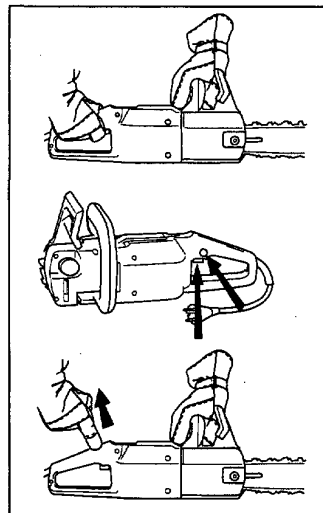

To stop

The saw will stop when you release the start button.

3 Chain catcher

The chain catcher is designed to catch the chain if it snaps or jumps off. This should not happen if the chain is properly tensioned (see section on "Assembly") and if the bar and chain are properly serviced and maintained. (See section on "General working instructions").

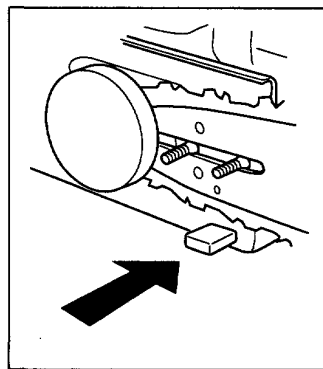

4 Right hand guard

Apart from protecting your hand if the chain jumps or snaps, the right hand guard stops branches and twigs from interfering with your grip on the rear handle.

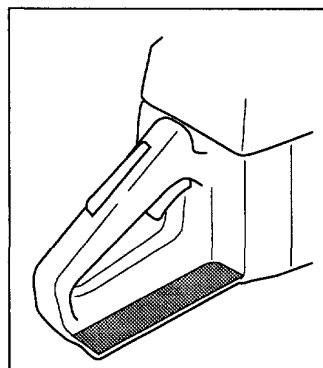

SAFETY INSTRUCTIONS

5 Sliding clutch 1400/1600W

The saw is equipped with a sliding clutch. This protects it from overloading. If the chain stops while the motor is running then the saw is overloaded. Ease up on the cutting pressure until the chain begins to turn again. If the blade has jammed stop the saw immediately and free the blade. If the chain stops frequently while cutting it may be because the chain is blunt. If so, sharpen the chain.

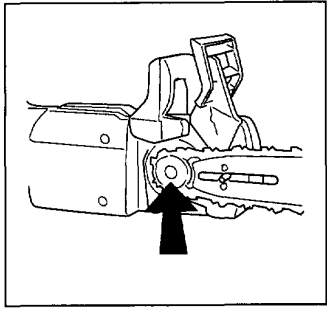

Electronic overload cut-out 1600W

The 1600W saw is equipped with an overload cut-out. The saw stops if this is triggered. To restart, release the start control. Make sure the chain has not jammed and is able to turn freely. Press the start control again.

Inspecting, maintaining and servicing chain saw safety equipment



SPECIAL TRAINING IS REQUIRED to service and repair chain saws. This is especially true of chain saw safety equipment. If your chain saw fails any of the checks described below take it to your **SERVICE AGENT**. When you buy any of our products we guarantee the availability of professional repairs and service. If the retailer who sells your saw is not a **SERVICING DEALER**, ask him for the address of your nearest **SERVICE AGENT**.

1 Chain brake and safety trigger

1 Checking brake band wear

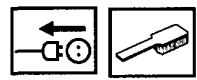

Brush off any sawdust, resin and dirt from the chain brake. Dirt and wear can impair operation of the brake.

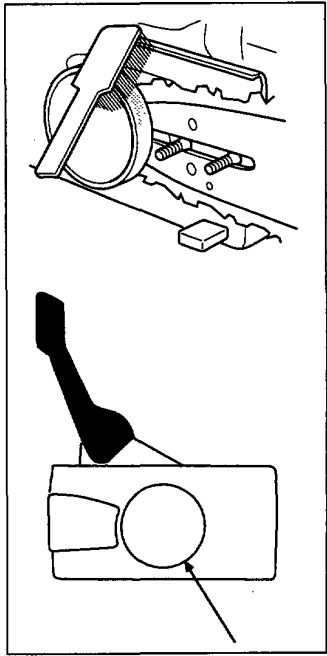

Regularly check that the brake band is at least 0.6 mm thick at its thinnest point.

2 Checking the safety trigger



A Make sure the **SAFETY TRIGGER** is not damaged and that there are visible defects such as cracks.

B Move the safety trigger forwards and back to make sure it runs freely and that it is securely anchored to the clutch cover.

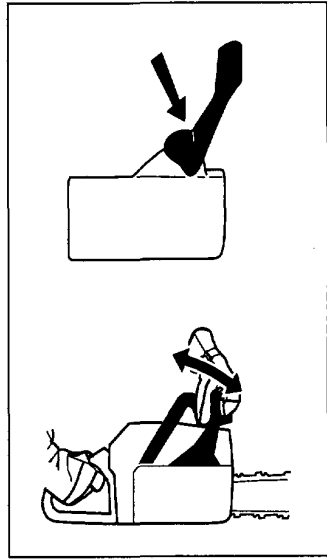

SAFETY INSTRUCTIONS

3 Checking the brake trigger

The chain brake must be checked several times daily. Place the saw on firm ground. Keep a firm grip on the saw with your right hand on the rear handle, your left hand on the front handle, and with your thumbs and fingers encircling the handle and apply throttle. Activate the chain brake by turning your left wrist against the hand guard, without releasing your grip around the front handle. The chain should stop immediately (illustr.).

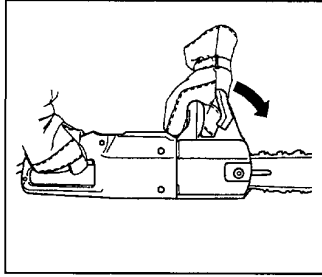

4 Checking the automatic brake



The chain brake must be checked several times daily. Hold the chain saw approx. 45 cm (18") above a trunk or other firm object.

CAUTION! The engine must be shut off.

Release your grip around the front handle and let the saw by its own weight rotate around the rear handle. When the tip of the bar hits the trunk, the brake should activate.



2 Power trigger lockout

Grasp the front handle with your left hand. Grasp the rear handle with your right hand. Push in the lock button using your right thumb and press the start button.

To stop

The saw will stop when you release the start button.

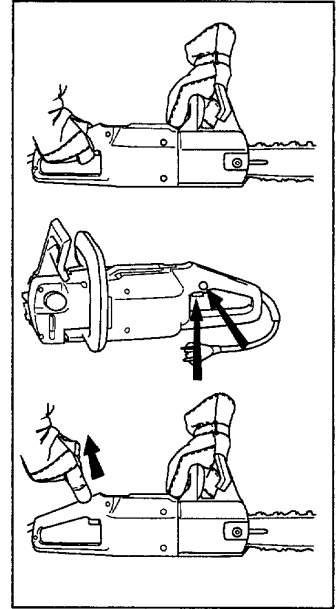

3 Chain catcher



Check that the CHAIN CATCHER is not damaged and is firmly attached to the body of the saw.

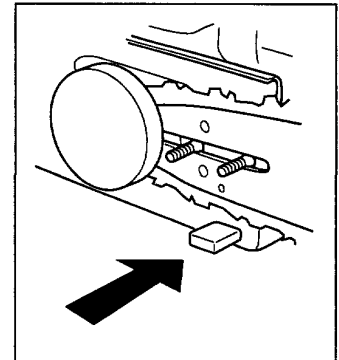

4 Right hand guard



Check that the right hand guard is not damaged and that there are no visible defects, such as cracks.

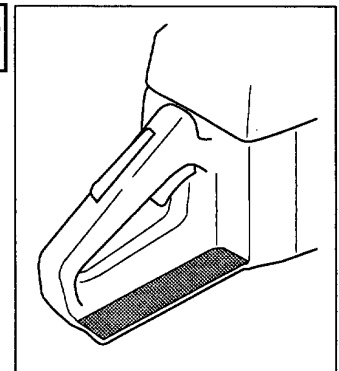

NEVER USE A CHAIN SAW WITH FAULTY SAFETY EQUIPMENT. CARRY OUT THE CHECKS AND MAINTENANCE MEASURES DESCRIBED IN THIS SECTION. IF YOUR CHAIN SAW FAILS ANY OF THESE CHECKS CONTACT YOUR SERVICE AGENT TO GET IT REPAIRED.

SAFETY INSTRUCTIONS

CUTTING EQUIPMENT

This section describes how to choose and maintain your cutting equipment in order to:

- Reduce the risk of kickback.
- Reduce the risk of the chain breaking or jumping.
- Obtain maximum cutting performance.
- Extend the life of cutting equipment.

The 5 basic rules

- 1 Only use cutting equipment recommended by us!**
See the "Technical data" section.
- 2 Keep the chain cutting teeth properly sharpened! Follow our instructions and use the recommended file gauge.** A damaged or badly sharpened chain increases the risk of accidents.
- 3 Maintain the correct raker clearance! Follow our instructions and use the recommended raker gauge.** Too large a clearance increases the risk of kickback.
- 4 Keep the chain properly tensioned!** If the chain is slack it is more likely to jump off and lead to increased wear on the bar, chain and drive sprocket.
- 5 Keep cutting equipment well lubricated and properly maintained!** A poorly lubricated chain is more likely to break and lead to increased wear on the bar, chain and drive sprocket.

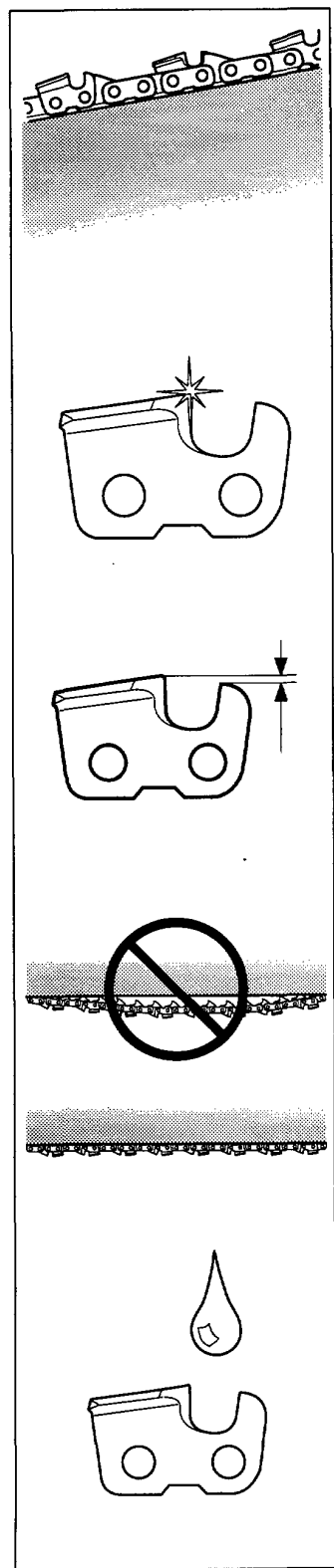

1 Cutting equipment designed to minimise kickback



Faulty cutting equipment or the wrong combination of bar and chain increases the risk of kickback. Use only the bar and chain combinations recommended in the "Technical data" section.

The only way to avoid kickback is to make sure that the kickback zone of the bar never touches anything. By using cutting equipment with "built-in" kickback protection and keeping the chain sharp and well-maintained you can reduce the effects of kickback.

A Bar

The smaller the tip radius the smaller the kickback zone and the lower the chance of kickback.

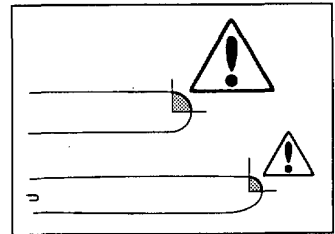

B Saw chain

A saw chain is made up of a number of links, which are available in standard and low-kickback versions.

	None	Standard	Low-kickback
CUTTING LINK			
DRIVE LINK			
SIDE LINK			

Combining these links in different ways gives different degrees of kickback reduction. In terms of kickback reduction alone, four different types of link are available.

Kickback reduction	Cutting link	Drive link	Side link
LOW			
STANDARD			
HIGH			
EXTRA HIGH			

SAFETY INSTRUCTIONS

C Some terms that describe the bar and chain

When the cutting equipment supplied with your saw becomes worn or damaged you will need to replace it. Use only the type of bar and chain recommended by us. See the "Technical data" section to find out which equipment is recommended for your saw.

Bar

- **LENGTH (inches/cm)**
- **NUMBER OF TEETH ON BAR TIP SPROCKET (T).**
Small number = small tip radius = low-kickback
- **CHAIN PITCH (inches)**
The spacing between the drive links of the chain must match the spacing of the teeth on the bar tip sprocket and drive sprocket.
- **NUMBER OF DRIVE LINKS**
The number of drive links is determined by the length of the bar, the chain pitch and the number of teeth on the bar tip sprocket.
- **BAR GROOVE WIDTH (inches/mm)**
The groove in the bar must match the width of the chain drive links.
- **SAW CHAIN OIL HOLE AND HOLE FOR CHAIN TENSIONER**
The bar must be matched to the chain saw design.

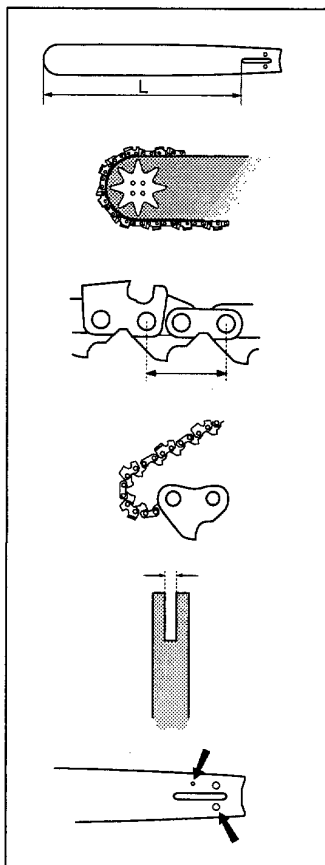

Saw chain

- **SAW CHAIN PITCH (inches)**
Spacing between drive links.
- **DRIVE LINK WIDTH (mm/inches)**
- **NUMBER OF DRIVE LINKS**
- **LEVEL OF KICKBACK REDUCTION**
The level of kickback reduction offered by a chain is indicated by its model number. See the "Technical data" section to find the model numbers of chains that are recommended for use with your saw.

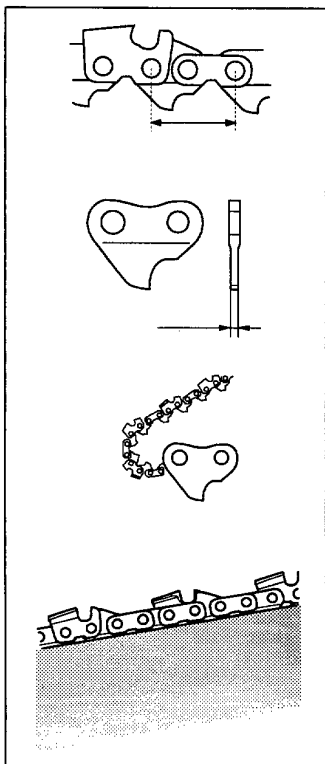

2 Sharpening your chain and adjusting raker clearance

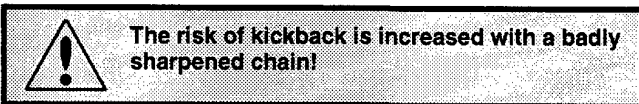

A General information on sharpening cutting teeth

- Never use a blunt chain. When the chain is blunt you have to exert more pressure to force the bar through the wood and the cuttings will be very small. If the chain is very blunt it will not produce any cuttings at all, just wood powder.
- A sharp chain eats its way through the wood and produces long, thick cuttings.
- The cutting part of the chain is called the **CUTTING LINK** and this consists of a **CUTTING TOOTH (A)** and the **RAKER LIP (B)**. The cutting depth is determined by the difference in height between the two.
- When you sharpen a cutting tooth there are five important factors to remember.

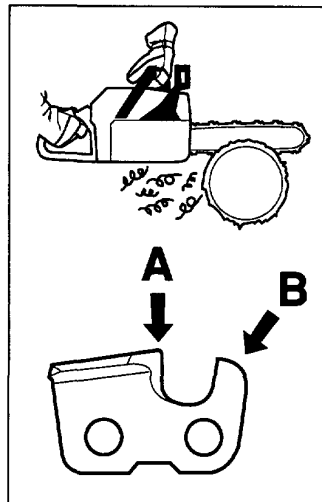

FILING ANGLE

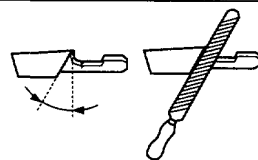

CUTTING ANGLE

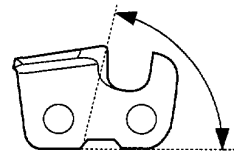

FILE POSITION



ROUND FILE DIAMETER

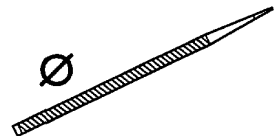

FILE DEPTH

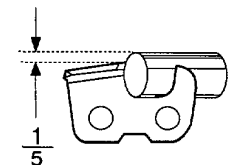

See the "Technical data" section for information about sharpening your saw chain.

SAFETY INSTRUCTIONS

It is very difficult to sharpen a chain correctly without the right equipment. We recommend you use a file gauge. This will help you obtain the maximum kickback reduction and cutting performance from your chain.

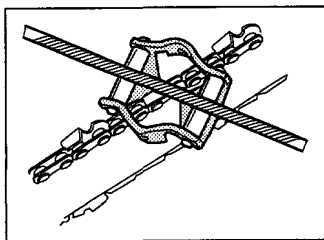

The following faults will increase the risk of kickback considerably.

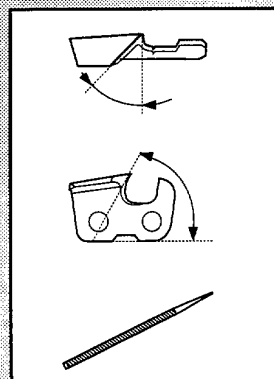

- FILE ANGLE TOO LARGE
- CUTTING ANGLE TOO SMALL
- FILE DIAMETER TOO SMALL

B Sharpening cutting teeth

To sharpen cutting teeth you will need a ROUND FILE and a FILE GAUGE. See the "Technical data" section for information on the size of file and gauge that are recommended for your saw chain.

- 1 Check that the chain is correctly tensioned. A slack chain is difficult to sharpen correctly.
- 2 Always file cutting teeth from the inside face, reducing the pressure on the return stroke.

File all the teeth on one side first, then turn the saw over and file the teeth on the other side.
- 3 File all the teeth to the same length. When the length of the cutting teeth is reduced to 4 mm (.16") the chain is worn out and should be replaced.

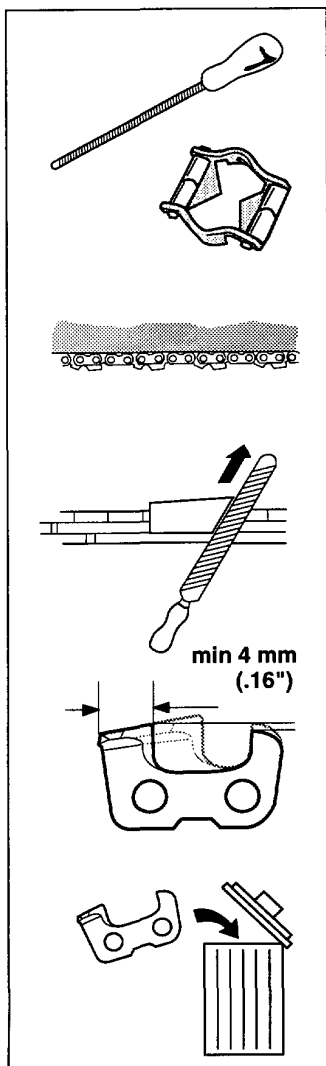

C General advice on setting raker clearance

- When you sharpen the cutting teeth you reduce the RAKER CLEARANCE (cutting depth). To maintain cutting performance you must file back the raker teeth to the recommended height.

See the "Technical data" section to find the raker clearance for your saw chain.

- On a low-kickback cutting link the front edge of the raker lip is rounded. It is very important that you maintain this radius or bevel when you adjust the raker clearance.
- We recommend the use of a raker gauge to achieve the correct clearance and bevel on the raker lip.

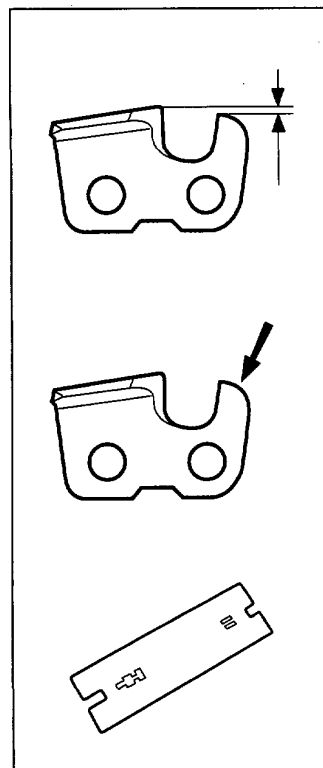

The risk of kickback is increased if the raker clearance is too large!

SAFETY INSTRUCTIONS

D Setting the raker clearance



- Before setting the raker clearance the cutting teeth should be newly sharpened.
We recommend that you adjust the raker clearance every third time you sharpen the chain. **NOTE!** This recommendation assumes that the length of the cutting teeth is not reduced excessively.

- To adjust the raker clearance you will need a **FLAT FILE** and a **RAKER GAUGE**.

- Place the gauge over the raker lip.

- Place the file over the part of the lip that protrudes through the gauge and file off the excess. The clearance is correct when you no longer feel any resistance as you draw the file over the gauge.

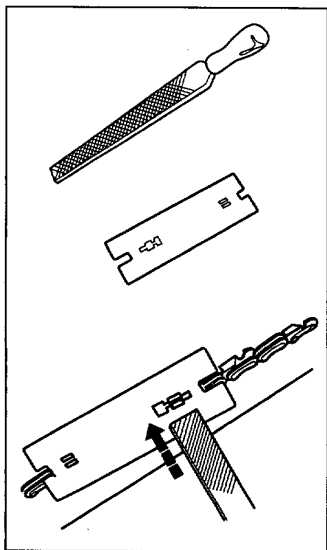

3 Tensioning the chain

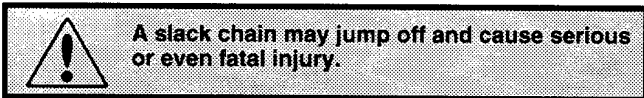

- The more you use a chain the longer it becomes. It is therefore important to adjust the chain regularly to take up the slack.
- Check the chain tension every time you refuel.
NOTE! A new saw chain has a running-in period during which you should check the tension more frequently.

- Tension the chain as tightly as possible, but not so tight that you cannot pull it round freely by hand.

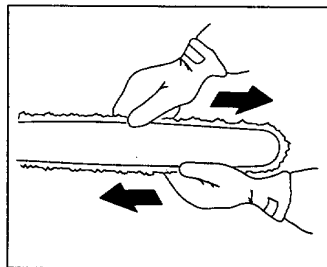

- 1 Undo the bar nuts that hold the clutch cover and chain brake, using the combination spanner. Then tighten the nuts by hand as tight as you can.
- 2 Raise the tip of the bar and stretch the chain by tightening the chain tensioning screw using the combination spanner. Tighten the chain until it hangs slack on the underside of the bar.
- 3 Use the combination spanner to tighten the bar nuts while lifting the tip of the bar at the same time. Check that you can pull the chain round freely by hand and that it is not slack on the bottom of the bar.

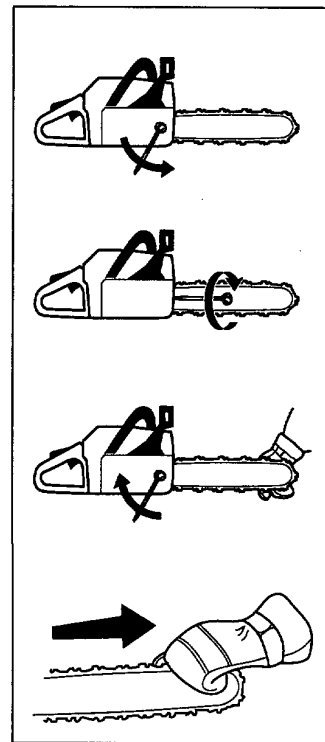

The position of the chain tensioning screw varies from model to model. See the "What is what" section to find out where it is on your saw.

SAFETY INSTRUCTIONS

4 Lubricating cutting equipment

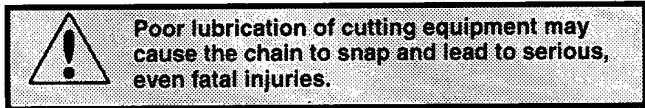

A Chain oil

- Chain oil should form a smooth film on the surface of the chain and maintain its flow properties regardless of the temperature.
- As a chain saw manufacturer we have developed a high quality chain oil, which, because it is vegetable-based, is also fully biodegradable. We recommend you use this oil to get the maximum life from your chain and protect the environment.
- If you cannot obtain our chain oil then we recommend a standard chain oil.
- If you cannot obtain oil specially designed for saw chain lubrication then EP 90 gearbox oil can be used.
- **Never use waste oil!**

B Filling with chain oil

- All our chain saws have an automatic chain lubrication system. On some models the oil flow is also adjustable.

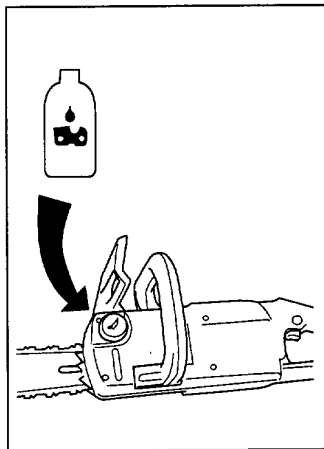

C Checking chain lubrication

Refill chain oil regularly. Never run the chain dry.

Point the tip of the bar towards a light surface about 20 cm away. After the saw has been running for 1/2 - 1 minute there should be an obvious patch of sprayed oil on the surface.

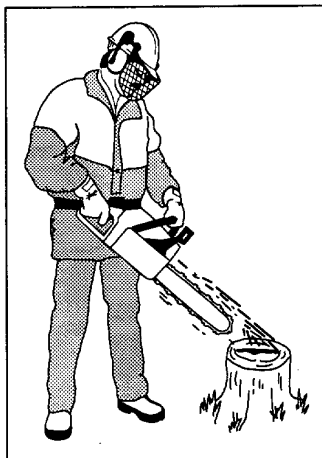

If the chain lubrication is not working:

- 1 Check that the oil channel in the bar is not obstructed. Clean if necessary.
- 2 Check that the groove in the edge of the bar is clean. Clean if necessary.
- 3 Check that the bar tip sprocket turns freely and that the lubricating hole in the tip is not blocked. Clean and lubricate if necessary.

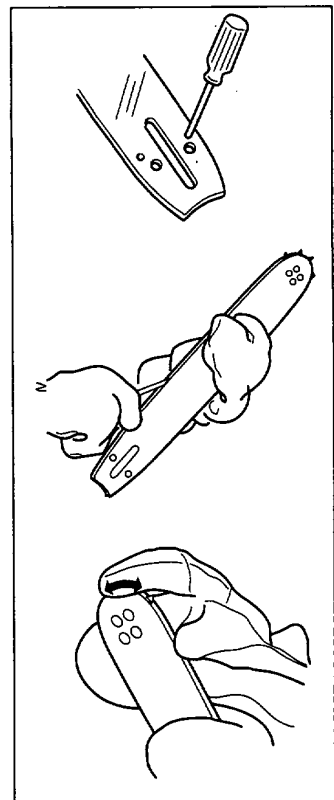

If the chain lubrication system is still not working after carrying out the above measures you should **contact your service agent**.

D Lubricating the bar tip sprocket



Check daily for:

- Cracks in rivets and links of the chain.
- Excessive wear on side links and cutters or stiffness in the chain.
- A cutter should never be filed to less than 5/32 inch or 4 mm.
- Correct depth gauge setting.

NOTE! Change the drive sprocket each time you fit a new chain.

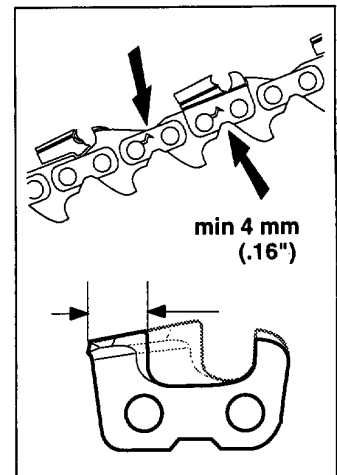

SAFETY INSTRUCTIONS

E Chain drive sprocket



The clutch drum is fitted with one of the following drive sprockets:

A SPUR (integral drive sprocket)

B RING (replaceable)

Regularly check the degree of wear on the drive sprocket. Replace if wear is excessive.

Replace the drive sprocket whenever you replace the chain.

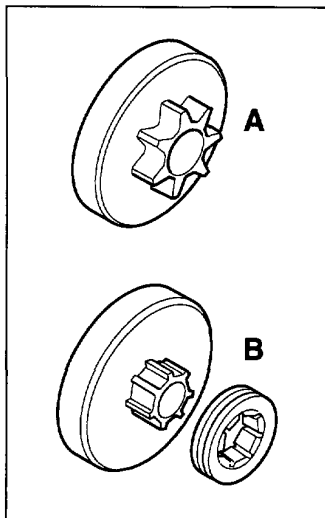

F Bar



Check regularly:

- Whether there are burrs on the edges of the bar. Remove these with a file if necessary.
- Whether the groove in the bar has become worn. Replace the bar if necessary.
- Whether the tip of the bar is uneven or badly worn. If a hollow forms on one side of the bar tip this is due to a slack chain.
- To prolong the life of the bar you should turn it over daily.

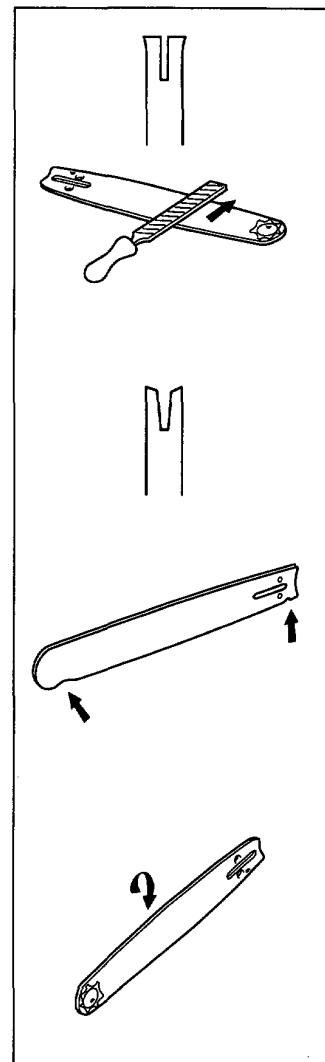

MOST CHAIN SAW ACCIDENTS HAPPEN WHEN THE CHAIN TOUCHES THE OPERATOR.

- **WEAR PERSONAL SAFETY EQUIPMENT** (see the section on "*Chain saw safety equipment*").
- **DO NOT TACKLE ANY JOB YOU ARE UNSURE OF** (see the section on "*Personal safety equipment*", "*How to avoid kickback*" and "*Cutting equipment*").
- **AVOID SITUATIONS WHERE THERE IS A RISK OF KICKBACK** (see the section on "*Personal safety equipment*").
- **USE THE RECOMMENDED SAFETY EQUIPMENT AND CHECK ITS CONDITION** (see section on "*General working instructions*").
- **CHECK THAT ALL SAFETY FUNCTIONS ARE WORKING** (see section on "*General working instructions*" and "*General safety precautions*").

SAFETY INSTRUCTIONS

HOW TO AVOID KICKBACK



Kickback can happen very suddenly and violently; kicking the saw, bar and chain back at the user. If this happens when the chain is moving it can cause very serious, even fatal injuries. It is vital you understand what causes kickback and that you can avoid it by taking care and using the right working technique.

What is kickback?

The word kickback is used to describe the sudden reaction that happens when the upper quadrant of the tip of the bar (known as the "kickback zone") touches an object and the saw is kicked backwards.

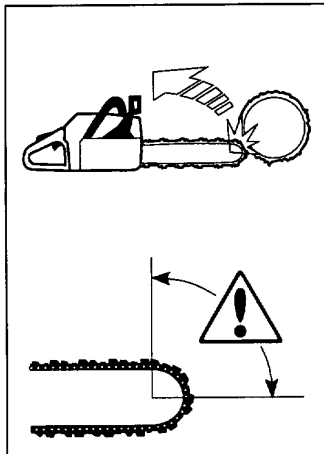

Kickback always occurs in the cutting plane of the saw. Normally the saw and bar are thrown backwards and upwards towards the user. However the saw may move in a different direction depending on the way it was being used when the kickback zone of the bar touched the object.



Kickback only occurs if the kickback zone of the bar touches an object.

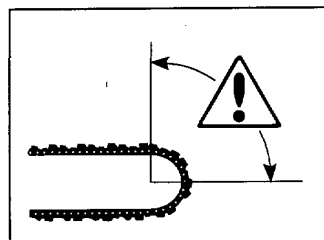

General rules

1 If you understand what kickback is and how it happens then you can reduce or eliminate the element of surprise. By being prepared you reduce the risk. Kickback is usually quite mild, but it can sometimes be very sudden and violent.

2 Always hold the saw firmly with your right hand on the rear handle and your left hand on the front handle.

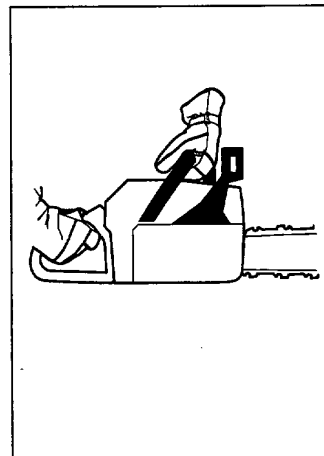

Wrap your fingers and thumb around the handles. You should use this grip whether you are right-handed or left-handed. This grip minimises the effect of kickback and lets you keep the saw under control.

Do not let go of the handles!

3 Most kickback accidents happen during limbing. Make sure you are standing firmly and that there is nothing in the way that might make you trip or lose your balance.

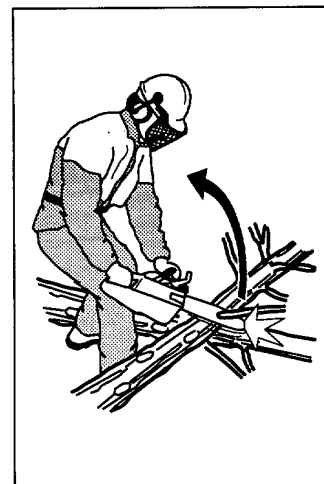

Lack of concentration can lead to kickback if the kickback zone of the bar accidentally touches a branch, nearby tree or some other object.

4 Never use the saw above shoulder height and try not to cut with the tip of the bar.

Never use the saw one-handed!



5 Always use a fast cutting speed.

SAFETY INSTRUCTIONS

6 Take great care when you cut with the top edge of the bar, i.e. when cutting from the underside of the object. This is known as cutting on the push stroke. The chain tries to push the saw back towards the user.

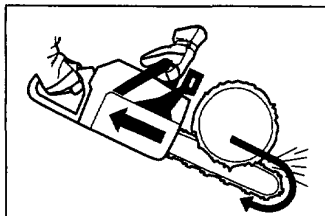

Unless the user resists this pushing force there is a risk that the saw will move so far backwards that only the kickback zone of the bar is in contact with the tree. This will cause kickback.



Cutting with the bottom edge of the bar, i.e. from the top of the object downwards, is known as cutting on the pull stroke.

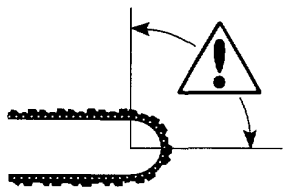

In this case the saw pulls itself towards the tree and the front edge of the saw provides a natural rest when cutting. Cutting on the pull stroke gives you better control over the saw and the position of the kickback zone.

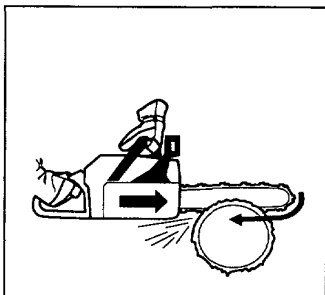

7 Follow the instructions on sharpening and maintaining your bar and chain. When you replace the bar and chain use only combinations that are recommended by us. See the sections on "Cutting equipment" and "Technical dat"



The risk of kickback is increased if you use the wrong cutting equipment or a chain that is not sharpened correctly. The wrong combination of bar and chain can increase the risk of kickback!

GENERAL SAFETY PRECAUTIONS

1 Chain saws are designed solely for cutting wood. The only cutting equipment that can be used with this chain saw are the combinations of bars and chains recommended in the "Technical data" section.

2 Never use a chain saw if you are tired, if you have drunk alcohol, or if you are taking medication that affects your vision, your judgement or your coordination.

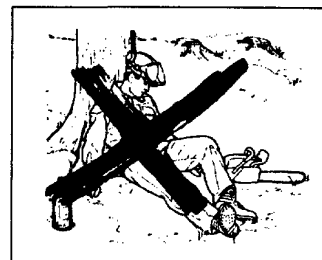

3 Always wear suitable safety clothing. See the section on "Personal safety equipment".

4 Never use a chain saw that has been modified in any way from its original specification.

5 Never use a chain saw that is faulty. Carry out the regular checks, maintenance and service routines described in this manual. Some maintenance and service measures must be carried out by trained specialists. See the section on "Maintenance".

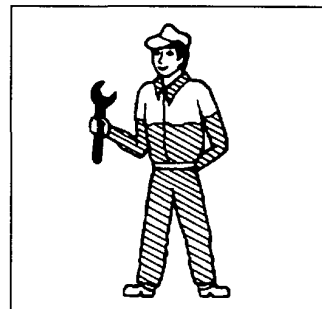

6 Start and stop

WARNING!

- Never start the saw engine without the bar, chain and clutch cover assembled - or else the clutch can come loose and cause personal injuries.
- Make sure that the chain is not contacting anything. Also, make sure that you have a secure footing.
- Keep people and animals well away from the working area.

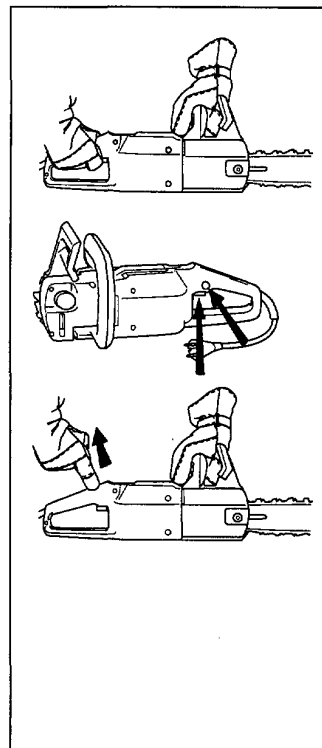

Starting up

Grasp the front handle with your left hand. Grasp the rear handle with your right hand. Push in the lock button using your right thumb and press the start button.

To stop

The saw will stop when you release the start button.



The risk of accident is increased if you use the wrong cutting equipment or a chain that is not sharpened correctly. Using the wrong combination of bar and chain can increase the risk of accidents!

SAFETY INSTRUCTIONS

GENERAL WORKING INSTRUCTIONS



This section describes basic safety rules for using a chain saw. This information is no substitute for professional skills and experience. If you get into a situation where you feel unsafe, stop and seek expert advice (look under FORESTRY SERVICES in the telephone directory). **DO NOT ATTEMPT ANY TASK THAT YOU FEEL UNSURE OF!**

Important

1 Before using a chain saw you must understand the effects of kickback and what causes it. (See the section on HOW TO AVOID KICKBACK).

2 Before using a saw you must understand the difference between sawing with the top and bottom edges of the bar. (See the section on HOW TO AVOID KICKBACK).

1 Basic safety rules

1 Look around you:

- to make sure there are no people, animals or other objects nearby that might affect your work.
- to make sure that none of the above might come within reach of your saw or be injured by falling trees.

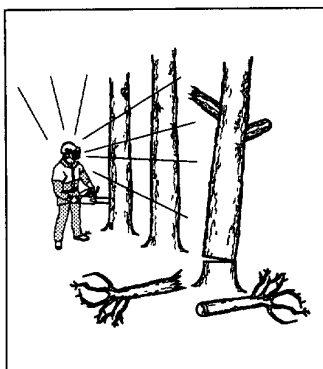

Follow the instructions above, but do not use a chain saw in a situation where you cannot call for help in case of an accident.

2 Do not use the saw in bad weather, such as dense fog, heavy rain, strong wind, intense cold, etc. Working in cold weather is tiring and often brings added risks, such as icy ground, unpredictable felling direction, etc.

3 Take great care when removing small branches and avoid cutting bushes (i.e. cutting many small branches at the same time). Small branches can be grabbed by the chain and thrown back at you, causing serious injury.

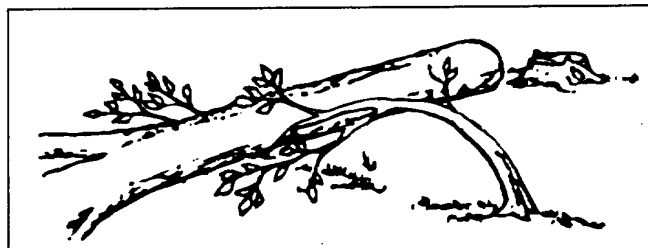

4 Check the area around you for possible obstacles such as roots, rocks, branches, ditches, etc., in case you have to move suddenly. Take great care when working on sloping ground.

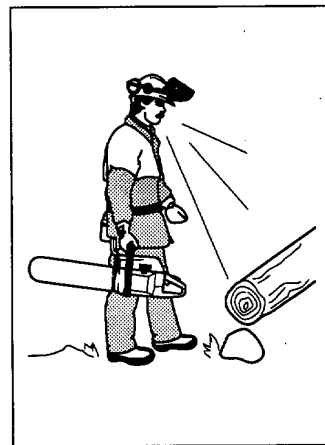

5 Take the utmost care when cutting through branches or logs that are in tension. A log or branch that is in tension can suddenly spring back into its natural position before or after you cut it. If you stand on the wrong side or start cutting in the wrong place it may strike you or your chain saw. This could make you lose control and cause a serious accident.



6 Before moving your chain saw switch off the engine and lock the chain using the chain brake. Carry the saw with the bar and chain pointing backwards. Fit a guard to the bar before carrying the saw any distance.

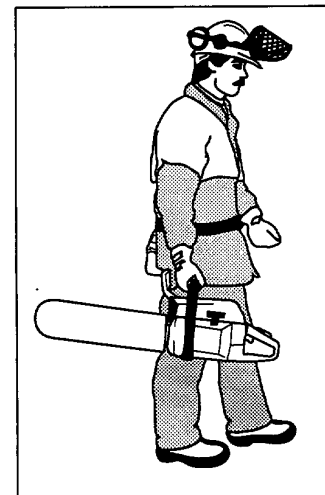

SAFETY INSTRUCTIONS

2 Basic cutting technique

General

- Cutting from above = Cutting on the pull stroke.
- Cutting from below = Cutting on the push stroke.

See the section on "How to avoid kickback" to find out why cutting on the push stroke increases the risk of kickback.

Terms:

- Cutting = General term for cutting through wood.
 Limbing = Cutting limbs off a felled tree.
 Splitting = When the object you are cutting breaks off before the cut is complete.

There are five important factors you should consider before making a cut:

- 1 Make sure the bar will not jam in the cut.

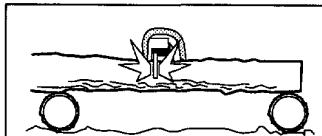

- 2 Make sure the log will not split.

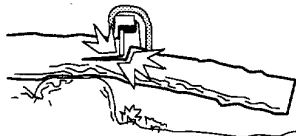

- 3 Make sure the chain will not strike the ground or any other object during or after cutting.



- 4 Is there a risk of kickback?

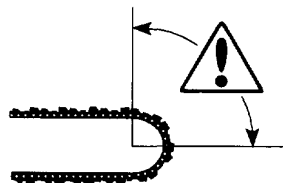

- 5 Do the conditions and surrounding terrain affect your safety when working?

Two factors decide whether the chain will jam or the log will split. The first is how the log is supported and the second is whether it is in tension.

In most cases you can avoid these problems by cutting in two stages; from the top and from the bottom of the log. You need to support the log so that it will not trap the chain or split during cutting.



**If the chain jams in the cut:
STOP THE MOTOR! Don't try to pull the saw free. If you do you may damage the chain when the saw suddenly breaks free. Use a lever to open up the cut and free the bar.**

The following instructions describe how to handle most types of situation that you will be faced with when using a chain saw.

Cutting

- 1 The log is lying on the ground. There is little risk of the chain jamming or the log splitting. However there is a risk that the chain will touch the ground when you finish the cut.

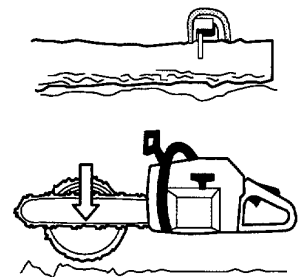

Cut all the way through the log from above. Try not to touch the ground as you finish the cut. Maintain full throttle but be prepared in case the chain snatches.

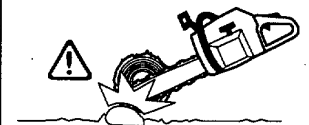

- A If it is possible to turn the log you should stop cutting about 2/3 of the way through.

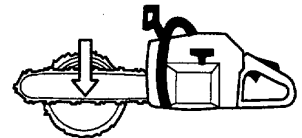

- B Turn the log and finish the cut from the opposite side.

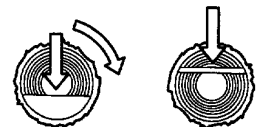

SAFETY INSTRUCTIONS

2 The log is supported at one end. There is a high risk that it will split.

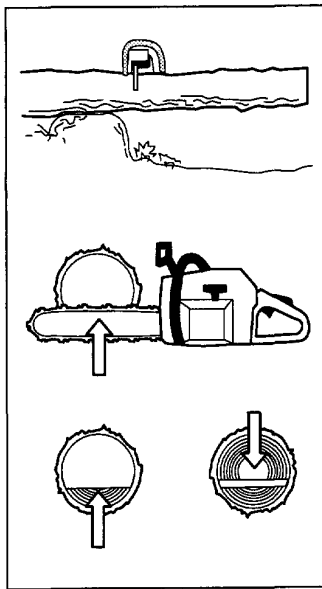

A Start by cutting from below (about 1/3 of the way through).

B Finish by cutting from above so that the two cuts meet.

3 The log is supported at both ends. There is a high risk that the chain will jam.

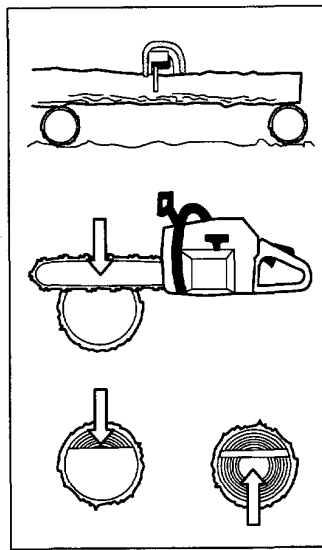

A Start by cutting from above (about 1/3 of the way through).

B Finish by cutting from below so that the two cuts meet.

Limbing
When limbing thick branches you should use the same approach as for cutting. Cut difficult branches piece by piece.

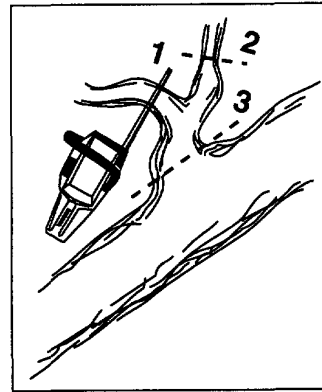

3 Tree felling technique

 It takes a lot of experience to fell a tree. Inexperienced users of chain saws should not fell trees. NEVER ATTEMPT A TASK YOU ARE UNSURE OF.

A Safe distance

The safe distance between a tree that is to be felled and anyone else working nearby is at least 2 1/2 tree lengths. Make sure that no-one else is in this "risk zone" before or during felling.

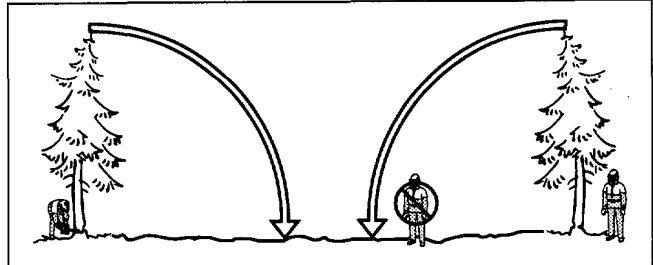

B Felling direction

The aim is to fell the tree in the best possible position for subsequent limbing and cross-cutting. You want it to fall on ground where you can move about safely.

The main point to avoid is letting the tree fall onto another tree. It can be both difficult and dangerous to remove a tree in such a position (see point 4 in this section). Once you have decided which way you want the tree to fall you must judge which way the tree would fall naturally.

Several factors affect this:

- Lean of the tree
- Bend
- Wind direction
- Arrangement of branches
- Weight of snow

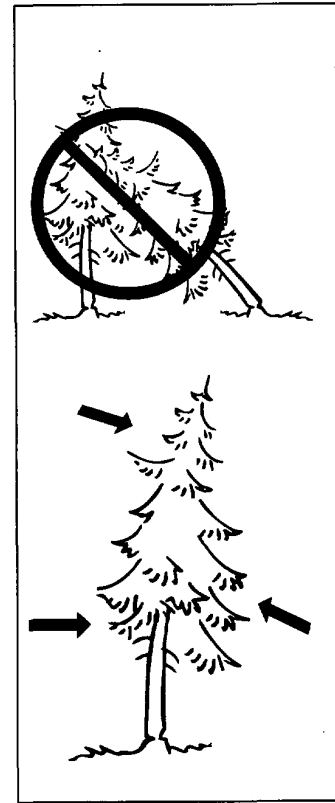

You may find you are forced to let the tree fall in its natural direction because it is impossible or dangerous to try to make it fall in the direction you first intended.

Another very important factor, which does not affect the felling direction but does affect your safety, is to make sure the tree has no damaged or dead branches that might break off and hit you during felling.

SAFETY INSTRUCTIONS

C Clearing the trunk and preparing your retreat

Remove any branches that are in the way. To do this it is best to work from the top down and keep the trunk between you and the chain saw. Never limb above shoulder height.

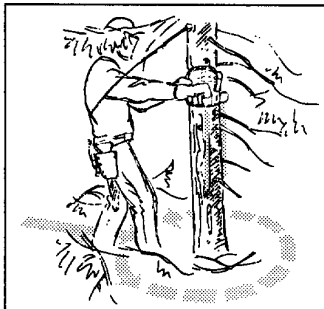

Remove any undergrowth from the base of the tree and check the area for obstacles (stones, branches, holes, etc.) so that you have a clear path of retreat when the tree starts to fall. Your path of retreat should be roughly 135 degrees behind the intended felling direction.

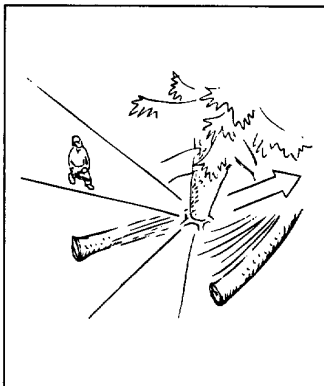

D Felling

Felling is done using three cuts. First you make the DIRECTIONAL CUTS, which consist of the TOP CUT and the BOTTOM CUT; followed by the FELLING CUT. By placing these cuts correctly you can control the felling direction very accurately.

DIRECTIONAL CUT

To make the DIRECTIONAL CUT you begin with the TOP CUT. Stand to the right of the tree and cut downwards at an angle.

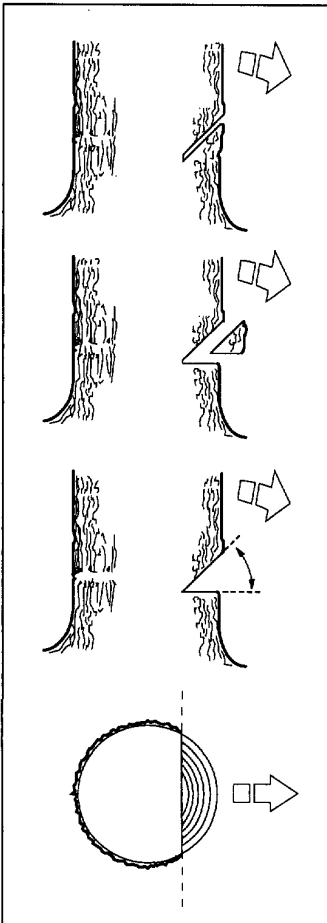

Next make the BOTTOM CUT so that it finishes at the end of the TOP CUT.

The directional cut should run 1/4 of the diameter through the trunk and the angle between the TOP CUT and BOTTOM CUT should be 45°.

The line where the two cuts meet is called the DIRECTIONAL CUT LINE. This line should be perfectly horizontal and at right angles (90°) to the chosen felling direction.

FELLING CUT

The felling cut is made from the opposite side of the tree and it must be perfectly horizontal. Stand on the left side of the tree and cut with the bottom edge of the bar.

Make the FELLING CUT about 3-5 cm (1.5-2 inches) above the flat section of the DIRECTIONAL CUT.

Use full throttle and bring the bar and chain slowly into the tree. Make sure the tree does not start to move in the opposite direction to your intended felling direction. Drive a WEDGE or BREAKING BAR into the cut as soon as it is deep enough.

Finish the FELLING CUT parallel with the DIRECTIONAL CUT LINE so that the distance between them is at least 1/10 of the trunk diameter. The uncut section of the trunk is called the BREAKING STRIP.

The BREAKING STRIP acts as a wedge that controls the felling direction of the falling tree.

All control over the felling direction is lost if the BREAKING STRIP is too narrow or if the directional cut and felling cut are badly placed.

When the felling cut and directional cut are complete the tree should start to fall under its own weight or with the aid of a FELLING WEDGE or BREAKING BAR.

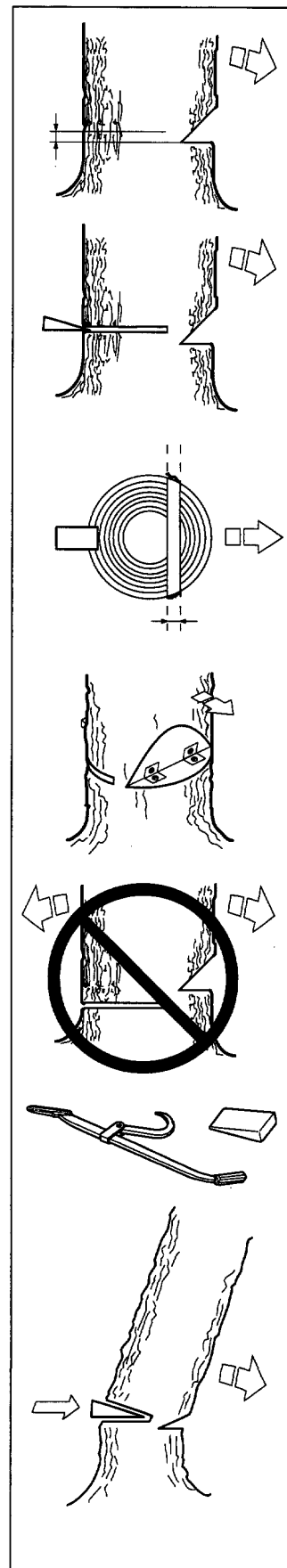

SAFETY INSTRUCTIONS

We recommend that you use a bar that is longer than the diameter of the tree, so that you can make the FELLING CUT and DIRECTIONAL CUT with single cutting strokes. (See "Technical data" to find out which lengths of bar are recommended for your saw).

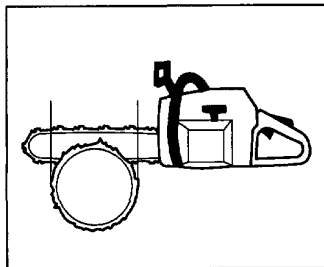

There are methods for felling trees with a diameter larger than the bar length. However these methods involve a much greater risk that the kickback zone of the bar will come into contact with the tree.

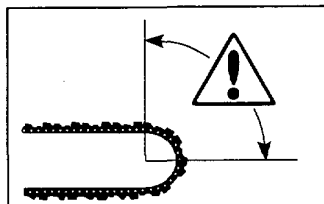

UNLESS YOU HAVE SPECIAL TRAINING WE ADVISE YOU NOT TO FELL TREES WITH A DIAMETER LARGER THAN THE BAR LENGTH OF YOUR SAW!

E Limbing

MOST KICKBACK ACCIDENTS HAPPEN DURING LIMBING. PAY CLOSE ATTENTION TO THE POSITION OF THE KICKBACK ZONE OF THE BAR WHEN YOU ARE LIMBING BRANCHES THAT ARE IN TENSION!

Make sure there are no obstacles in your way. Work on the left side of the trunk. Work close to the saw for maximum control. If possible, let the weight of the saw rest on the trunk.

Keep the tree between you and the saw as you move along the trunk.



F Cutting the trunk into logs

See chapter "General working instructions" point 2 "Basic cutting technique".

4 Freeing a tree that has fallen badly = high accident risk

A Freeing a "Trapped tree"

The safest method is to use a winch.

- A Tractor-mounted
- B Portable

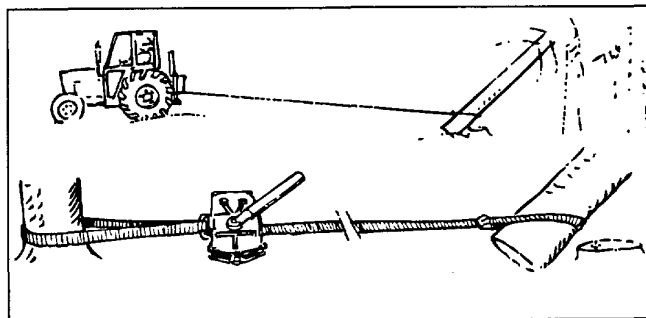

B Cutting trees and branches that are in tension

Preparations:

- a) Work out which way the tree or branch will move if released and where the natural "BREAKING POINT" is (i.e. the place it would break if it was bent even more).

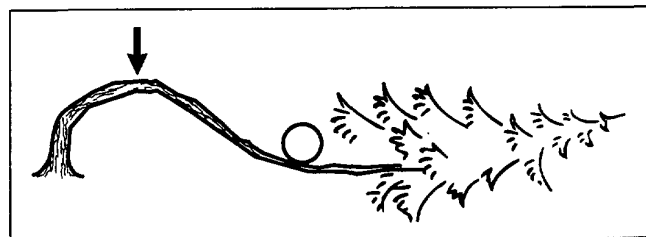

- b) Decide which is the SAFEST way to release the tension and whether YOU are able to do it safely. In complicated situations the only safe method is to put aside your chain saw and use a winch.

General advice:

- a) Position yourself so that you will be clear of the tree or branch when it springs free.
- b) Make one or more cuts at or near the BREAKING POINT. Make as many cuts of sufficient depth as necessary to reduce the tension and make the tree or branch break at the BREAKING POINT.

Never cut straight through a tree or branch that is IS in tension!

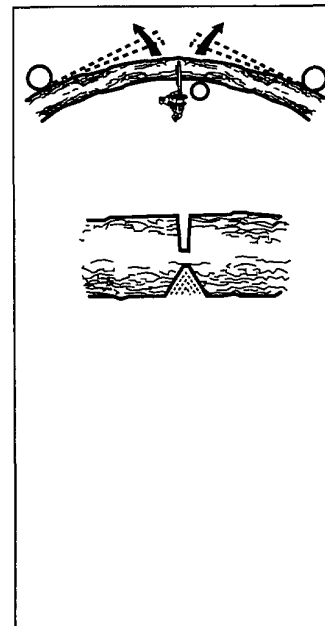

WHAT IS WHAT?

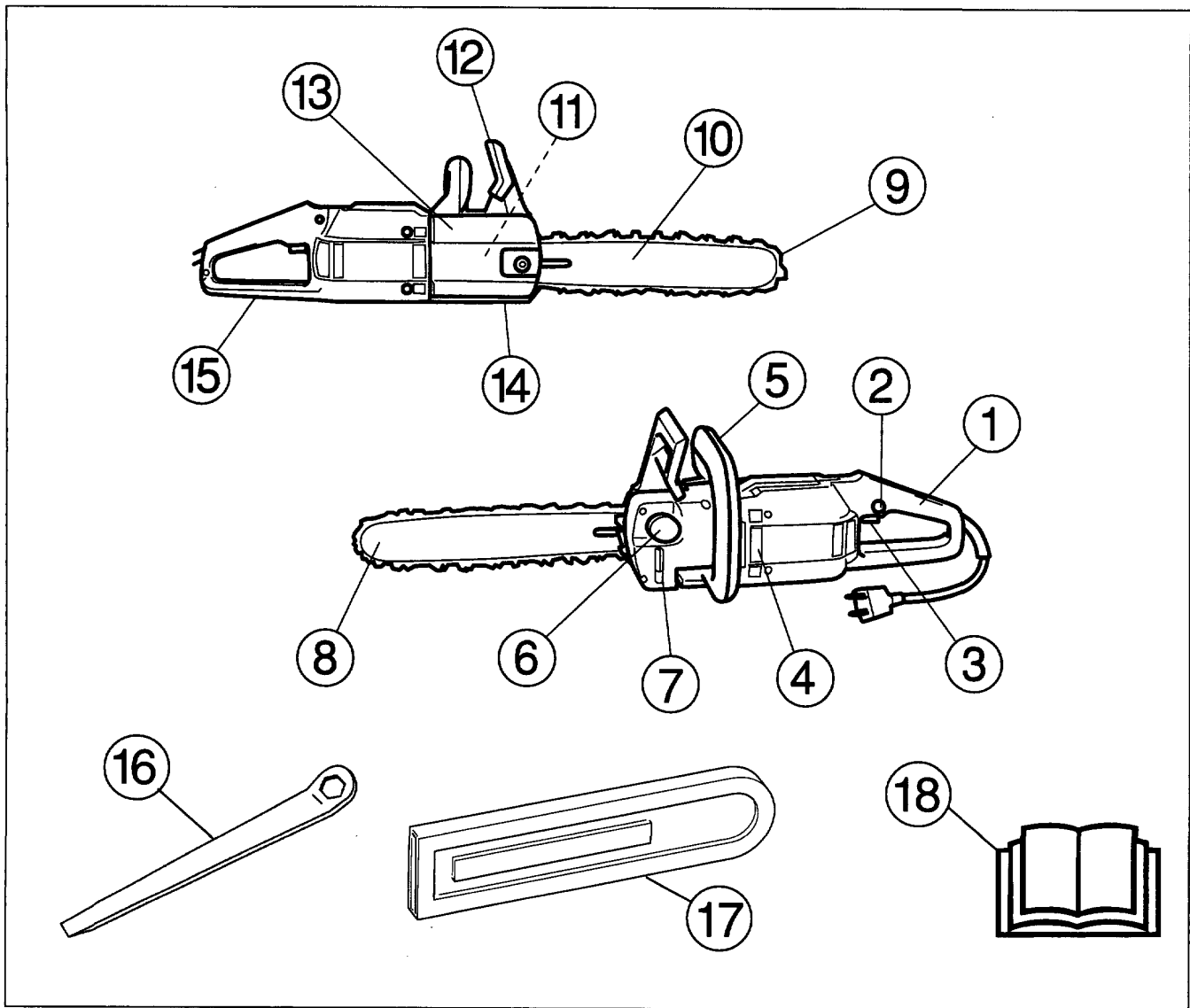

What is what on the saw?

- | | |
|--------------------------|---|
| 1. Rear handle | 11. Chain brake which is obscured by the clutch cover |
| 2. Power trigger lockout | 12. Front hand guard |
| 3. Power trigger | 13. Clutch cover |
| 4. Air vents | 14. Chain catcher - designed to catch the chain if the chain jumps or breaks |
| 5. Front handle | 15. Chain guard - designed to protect the right hand in the event of the chain jumping or breaking. |
| 6. Chain oil tank | 16. Combination spanner. |
| 7. Oil level window | 17. Bar guard. |
| 8. Nose sprocket | 18. Instruction manual. |
| 9. Saw chain | |
| 10. Bar | |

ASSEMBLY

Mounting guide bar and chain

 Always wear gloves, when working with the chain, in order to protect your hands from injury.



Check that the chain brake is in disengaged position by moving the front hand guard towards the front handle.

Take off the bar nuts and remove the clutch cover.

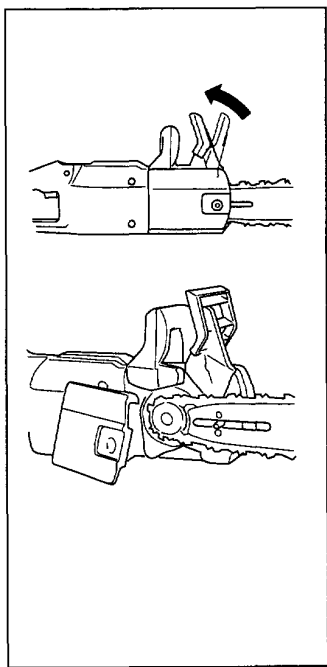

Fit the bar over the bar bolts. Place the bar in its rearmost position. Place the chain over the drive sprocket and in the groove on the bar. Begin on the top side of the bar. Make sure that the edges on the cutting links are facing forward on the top side of the bar.

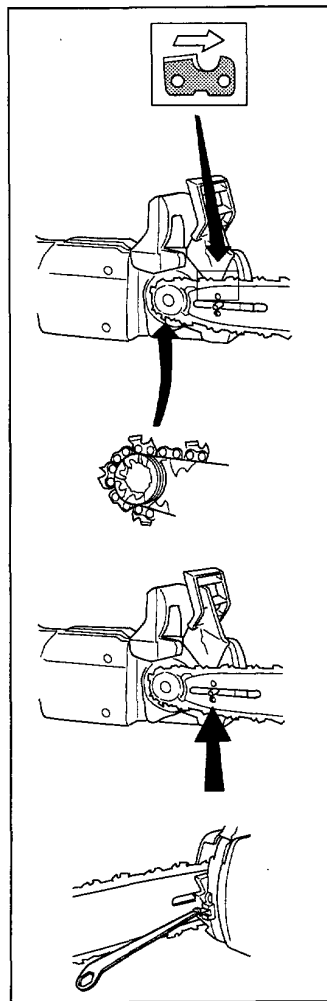

Fit the clutch cover and locate the chain adjuster pin in the hole on the bar. Check that the drive links of the chain fit correctly on the drive sprocket and that the chain is in the groove on the bar. Tighten the bar nuts finger tight. Tension the chain by using the combination wrench. Turn the chain adjuster screw clockwise. The chain should be tensioned until it fits snugly on the underside of the bar.



Hold up the tip of the bar and tighten the chain. The chain is correctly tensioned when there is no slack on the underside of the bar, but it can still be turned easily by hand. Hold up the bar tip and tighten the bar nuts with the combination wrench.

When fitting a new chain, the chain tension has to be checked frequently until the chain is run-in. Check the chain tension regularly. A correctly tensioned chain gives good cutting performance and long lifetime.

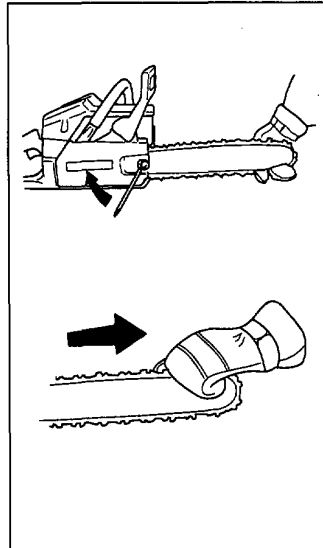

Chain oil

- The chain lubrication system is automatic. Always use special chain oil with good adhesive characteristics.
- In countries where no special chain oil is available, gear box oil EP 90 can be used.
- Never use waste oil. This results in damage to the oil pump, the bar and the chain.
- It is important to use oil of the right viscosity according to the air temperature.
- In temperatures below 0°C (32°F) some oils become less viscous. This can overload the oil pump and result in damage to the oil pump components.
- Contact your servicing dealer when choosing chain oil.

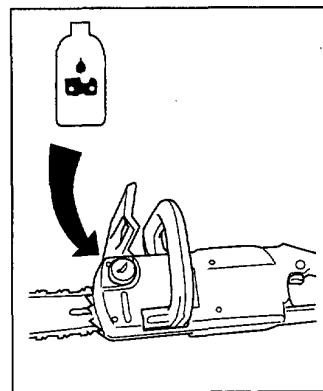

START AND STOP

Start and stop

WARNING!

- Never start the saw engine without the bar, chain and clutch cover assembled - or else the clutch can come loose and cause personal injuries.
- Make sure that the chain is not contacting anything. Also, make sure that you have a secure footing.
- Keep people and animals well away from the working area.

Starting up

Grasp the front handle with your left hand. Grasp the rear handle with your right hand. Push in the lock button using your right thumb and press the start button.

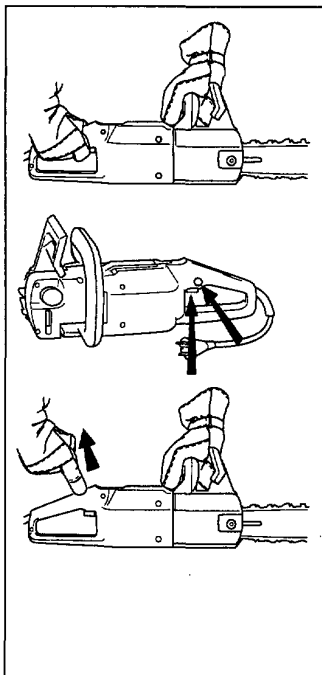

To stop

The saw will stop when you release the start button.

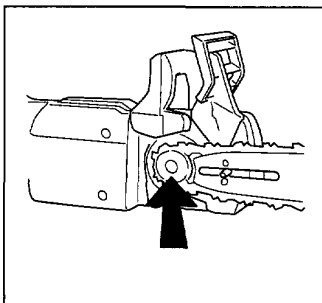

Sliding clutch 1400/1600W

The saw is equipped with a sliding clutch. This protects it from overloading. If the chain stops while the motor is running then the saw is overloaded. Ease up on the cutting pressure until the chain begins to turn again. If the blade has jammed stop the saw immediately and free the blade. If the chain stops frequently while cutting it may be because the chain is blunt. If so, sharpen the chain.

Electronic overload cut-out 1600W

The 1600W saw is equipped with an overload cut-out. The saw stops if this is triggered. To restart, release the start control. Make sure the chain has not jammed and is able to turn freely. Press the start control again.

MAINTENANCE

Saw maintenance

The following are some general maintenance instructions. If you have any further queries contact your service workshop.

WARNING! Always pull out the plug before fitting parts or adjusting the saw.

Daily maintenance

- Check the mains lead and plug for damage or splitting. A worn or defective lead or plug should always be replaced with new items.
- Clean the chain brake and check that it works safely. Check that the chain catcher is in good condition; replace if necessary.
- Check the air intakes.
- Check that bar and chain are well oiled.
- The bar should be turned daily to ensure even wear. Check that the oil hole in the bar is not blocked. Clean the chain guide.
- Sharpen the chain and check that it is correctly tensioned and in good condition.
- Check that there is no excessive wear on the chain drive sprocket. Replace if necessary.
- File off any burrs on the sides of the bar.

Sliding clutch

It may be necessary to clean the clutch after extended use. Contact your service workshop if it is necessary to clean the clutch.

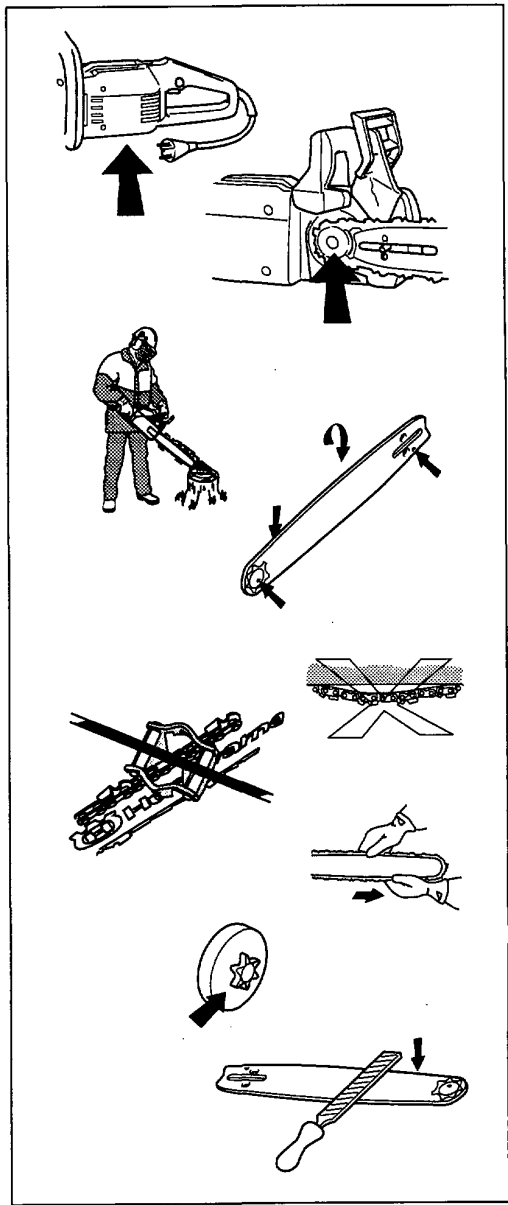

Technical specification

Engine

		1400	1600
Voltage	Volts	AC 230	230
Rated power	Watts	1400	1600
Sliding clutch		Yes	Yes
Electronic soft start		-	Yes
speed regulation		-	Yes
overload cut-out		-	Yes

Weight

Without bar and chain	kg	3.7	3.7
With 13" bar and chain	kg	4.5	4.5

Chain lubrication

Oil tank capacity	l	0.1	0.1
Oil pump		Auto	Auto

Chain/bar

Standard bar length	inch/cm	13/33	13/33
Recommended bar lengths	inch/cm	13/33	13/33
	inch/cm	15/38	15/38
Usable cutting length	inch/cm	13/32,5	13/32,5
	inch/cm	15/39,0	15/39,0
Chain speed unloaded	m/sec	15	15
Chain speed at power rating	m/sec	11(8t)	15(8t)
Chain pitch	inch	.325	.325
Thickness of drive links	mm	1.5	1.5
Number of drive links 13"/15"		56/64	56/64

Noise levels (see note. 1)

Equivalent noise pressure level at operator's ear, measured according to relevant international standards,	dB(A)	89	87,5
Equivalent noise power level, measured according to relevant international standards,	dB(A)	100,5	100

Vibration levels





Front handle,	m/s ²	2,1	4,5
Rear handle,	m/s ²	2,7	7,0

Note 1: Equivalent noise level is, according to ISO 7182 and ISO 9207, calculated as the time-weighted energy total for noise levels under various working conditions with the following time distribution: 1/3 idle, 1/3 full load, 1/3 full speed.

Saw is double insulated and manufactured in accordance with the relevant European safety regulations (CENELEC Publ. HD 400.3).

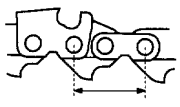
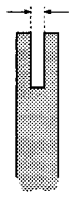
Manufacturer:

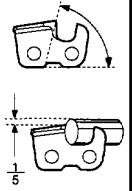
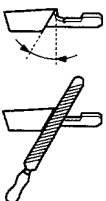
Electrolux Motor A/S, N-1701 Sarpsborg

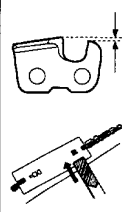
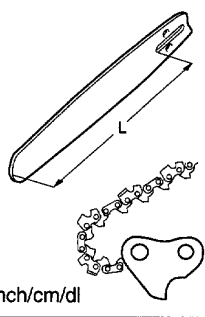
							
inch	inch/mm	inch/mm	°	°	°	inch/mm	inch/cm/dl
H-30 S30 Oregon 95VP	.325 .050/1,3	11/64" / 4,5	85°	30°	10°	.025/0,65	13/33/56 15/38/64