

**Operator's manual**  
**Rider 316T Rider 316T AWD**  
**Rider 316Ts AWD Rider 316TXs AWD**

Please read the operator's manual carefully and make sure you understand the instructions before using the machine.



**English**

# CONTENTS

## Contents

### CONTENTS

Contents .....	2
<b>Service journal</b>	
Pre-delivery service .....	3
After the first 8 hours .....	3
<b>INTRODUCTION</b>	
Dear Customer, .....	4
Driving and transport on public roads .....	4
Towing .....	4
Use .....	4
Good service .....	4
<b>KEY TO SYMBOLS</b>	
Symbols .....	5
<b>WHAT IS WHAT?</b>	
What is what on the ride-on mower .....	7
<b>SAFETY INSTRUCTIONS</b>	
Safety instructions .....	8
Driving on slopes .....	9
Children .....	10
Maintenance .....	10
Transport .....	11
<b>PRESENTATION</b>	
Presentation .....	12
Throttle trigger .....	12
Choke control .....	12
Speed limiter .....	12
Parking brake .....	12
Cutting unit .....	12
Lifting lever for the cutting unit .....	13
Cutting height adjustment lever .....	13
Lights .....	13
Counter .....	13
Seat .....	13
Fueling .....	13
Release lever .....	14
<b>Driving</b>	
Before starting .....	15
Start the engine .....	15
Starting the engine with a weak battery .....	16
Driving the Rider .....	16
Cutting tips .....	17
Stop the engine .....	17
<b>Maintenance</b>	
Maintenance schedule .....	18
Cleaning .....	19
Removing of the machine hoods .....	19
Checking and adjusting the steering wires .....	19
Adjusting the parking brake Rider 316T .....	20
Adjusting the parking brake .....	20
Checking and adjusting of throttle wire .....	20
Checking and adjusting the choke wire .....	21
Replacement of fuel filter .....	21
Checking the fuel pump's air filter .....	21
Replacing the air filter .....	21
Ignition system .....	22

Check the safety system .....	22
Replacing the light bulbs .....	22
Main fuse .....	23
Checking the tyre pressure .....	23
Checking the engine's cooling air intake .....	23
Fitting the cutting head .....	24
Removing the cutting unit .....	25
Checking and adjustment of the cutting unit's ground pressure .....	25
Checking the cutting unit's parallelism .....	25
Adjusting the parallelism of the cutting unit .....	26
Replacing the cutting unit belts .....	26
Service position for the cutting unit .....	27
Checking the blades .....	28
Removing the BioClip plug .....	28
<b>Lubrication</b>	
Checking the engine's oil level. ....	29
Changing the oil filter .....	29
Checking the transmission oil level .....	30
Lubricating the belt adjuster .....	30
General lubrication .....	30
<b>Troubleshooting schedule</b>	
<b>Storage</b>	
Winter storage .....	32
Guard .....	32
Service .....	32
<b>Technical data</b>	
EC-declaration of conformity .....	35

# Service journal

## Pre-delivery service

- 1 Charge the battery for 4 hours at max. 3 amp.
- 2 Fit steering wheel, seat and any optional equipment.
- 3 Check and adjust tyre pressure (60 Kpa, 0.6 bar, 9 PSI).
- 4 Adjust cutting unit:  
  
Adjust lift springs (effective weight of cutting unit should be 12-15kg / 26.5-33 lb).   
  
Adjust cutting unit so that rear edge is about 2-4 mm / 1/8" higher than front edge.   
  
Adjust the cutting unit's cutting height setting so that the connection rod is tensed at the lowest cutting height.
- 5 Check that the right amount of oil is in the engine.
- 6 Check that there is oil in the transmission's oil tank.
- 7 Connect battery.
- 8 Fill with fuel and start engine.
- 9 Check that machine does not move in neutral.
- 10 Check:  
  
Forward drive.   
  
Reverse drive.   
  
Operation of blades.   
  
Seat safety switch.   
  
Lif lever safety switch.   
  
The safety switch for the hydrostat pedals.
- 11 Check the engine speed See the Technical data section.
- 12 Check the synchronisation between the front and rear wheels. (Only AWD-machines) See the workshop manual.

13 Tell customer about:

- Needs and benefits of following the service schedule.
- Servicing and the influence of this journal on the second-hand value of the machine.
- Range of applications for BioClip.
- Complete proof of sale etc.

Pre-delivery service carried out. No outstanding problems. Certified:

---

Date, mileage, stamp, signature

## After the first 8 hours

- 1 Change engine oil
- 2 Change the oil in the gearbox. (Only AWD-machines)
- 3 Check the synchronisation between the front and rear wheels. (Only AWD-machines)

---

# INTRODUCTION

---

## Dear Customer,

Thank you for choosing a Husqvarna Rider. Husqvarna Riders are built to a unique design with a front-mounted cutting unit and a patented articulated steering. Riders are designed for maximum efficiency even in small or confined areas. The closely grouped controls and pedal-operated hydrostatic transmission also contribute to the performance of this machine.

This operator's manual is a valuable document. By following its instructions (on operation, service, maintenance, etc.) you will significantly extend the life of the machine and even its second-hand value.

When you sell your Rider, make sure you pass on the operator's manual to the new owner.

The last chapter in the operator's manual consists of a Service Journal. Make sure that all service work and repairs are recorded. A well-documented service history reduces the costs of seasonal maintenance and influences the second-hand value of the machine. Bring the operator's manual with the Rider when bringing it to a workshop for service procedures.

## Driving and transport on public roads

Check the relevant road traffic regulations before driving the machine on a public road. If transporting the machine on another vehicle always use approved securing devices and make sure that the machine is securely held.

## Towing

When your machine is equipped with a hydrostatic transmission you should only tow the machine over short distances and at a low speed, otherwise there is a risk of damaging the transmission.

The power transmission must be disengaged when towing, see the instructions under the heading Clutch control.

## Use

This ride-on mower is designed to mow grass on open and level ground surfaces. In addition, there is a number of accessories recommended by the manufacturer that broadens the application area. Please contact your dealer for more information about which accessories are available. The machine may only be used with the equipment recommended by the manufacturer. All other types of use are incorrect. Compliance with and strict adherence to the conditions of operation, service and repair as specified by the manufacturer also constitute essential elements of the intended use.

**IMPORTANT INFORMATION** The transmission guarantee is only valid if the synchronisation of the front and rear wheels has been checked and adjusted in compliance with the service schedule. The system will be damaged if synchronisation is not carried out.

This machine should be operated, serviced and repaired only by persons who are familiar with its particular characteristics and who are acquainted with the relevant safety procedures.

Accident prevention regulations, all other generally recognised regulations on safety and occupational medicine, and all road traffic regulations must be observed at all times.

Any arbitrary modifications carried out to this machine may relieve the manufacturer of liability for any resulting damage or injury.

## Good service

Husqvarna products are sold all over the world and ensures that you, the customer, get the best support and service. For example, before this machine was delivered it was inspected and adjusted by your dealer. See the certificate in the Service Journal in this manual.

When you need spare parts or advice on service issues, warranty terms, etc., contact:

This Operator's Manual belongs to machine with serial number:	Engine	Transmission

On the machine's rating plate you will find the following information:

- The machine's type designation.
- The manufacturer's type number.
- The machine's serial number.

State the type designation and serial number when ordering spare parts.

# KEY TO SYMBOLS

## Symbols

These symbols are on the machine and in the instructions.

WARNING! Careless or incorrect use can result in serious or fatal injury to the operator or others.



Please read the operator's manual carefully and make sure you understand the instructions before using the machine.



Always wear:

- Approved hearing protection



This product is in accordance with applicable EC directives.



Fast



Slow



Stop the engine.



Choke.



Fuel



Oil level



Cutting height



Backwards



Forwards



Ignition



Hydrostatic freewheel

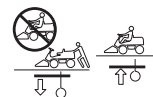

Parking brake



Noise emission to the environment according to the European Community's Directive. The machine's emission is specified in the Technical data chapter and on the label.



Clutch in



Clutch out



Warning: rotating parts. Keep hands and feet clear.

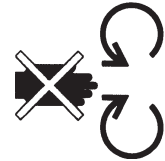

Rotary blades Keep hands and feet away from under the hood when the engine is running



Hot surface.



Risk that the machine will tip over



Never drive across a slope



Never use the machine if persons, especially children, or animals, are in the vicinity



Never carry passengers on the machine or equipment



Drive very slowly if no cutting unit is fitted



The cutting deck must be fitted at full speed.



Brake



# KEY TO SYMBOLS

Starting instructions

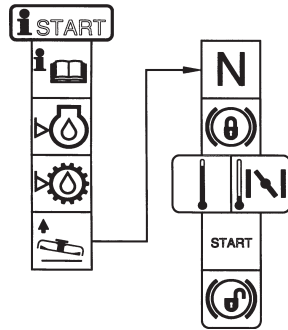

Switch off the engine and take off the ignition cable before repairs or maintenance



Check the engine's oil level



Check transmission oil level

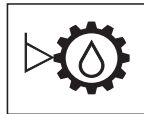

Lift up the cutting unit



Apply the parking brake.



If the engine is cold, use the choke

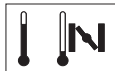

Release the parking brake before driving



# WHAT IS WHAT?

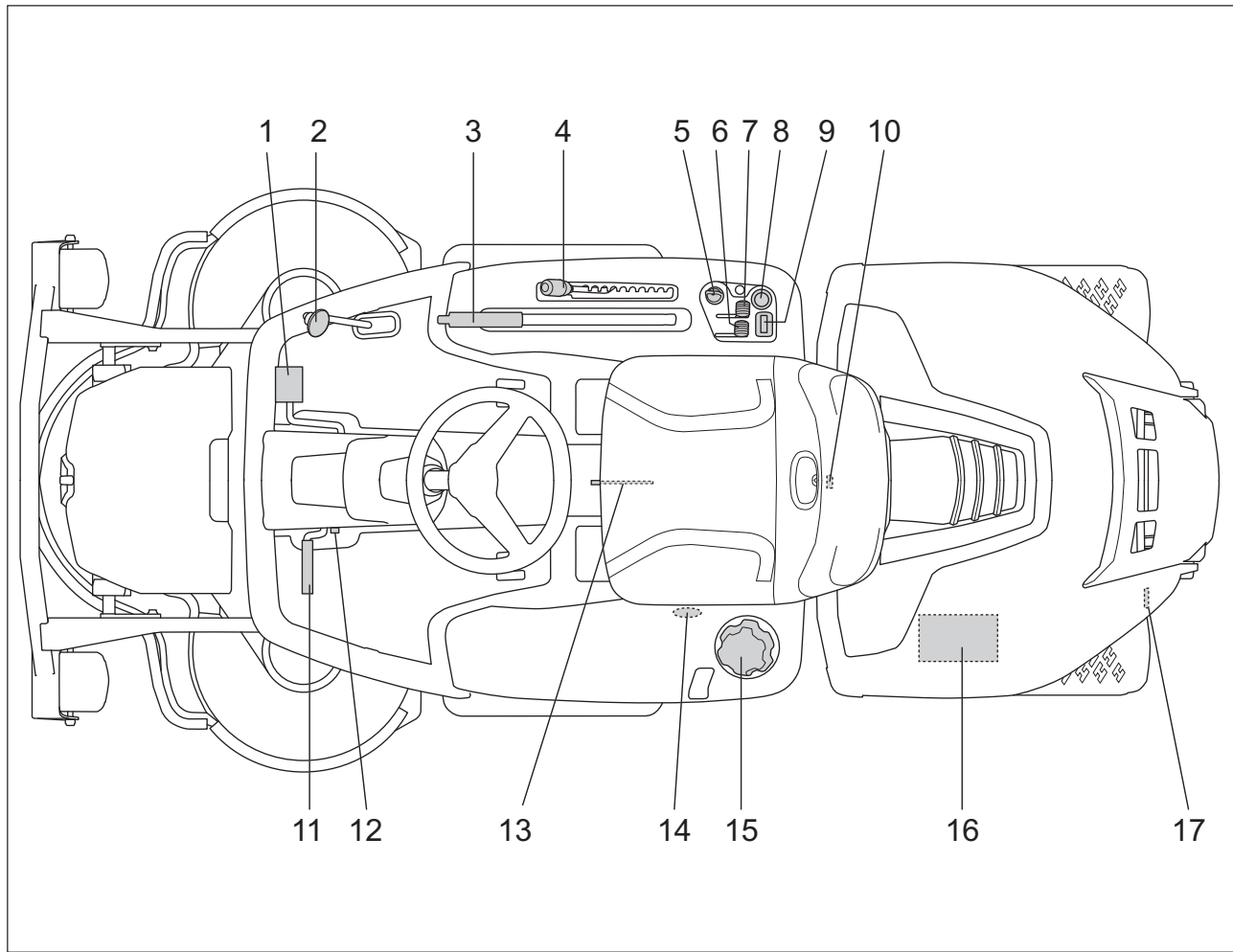

## What is what on the ride-on mower

- |                                      |   |
|--------------------------------------|---|
| 1 Speed limiter for driving forward  | 10 Cover lock   |
| 2 Speed limiter for reversing        | 11 Parking brake  |
| 3 Lifting lever for the cutting unit | 12 Lock button for parking brake  |
| 4 Cutting height adjustment lever    | 13 Seat adjustment.   |
| 5 Ignition lock                      | 14 Lever to disengage the driving front axle: 316T AWD, 316Ts AWD, 316TXs AWD   |
| 6 Throttle trigger                   | 15 Fuel cap   |
| 7 Choke control                      | 16 Battery  |
| 8 Power outlet                       | 17 Lever to disengage the drive Rider 316T<br>Lever to disengage the driving rear axle, 316T AWD, 316Ts AWD, 316TXs AWD |
| 9 Counter                            |   |

# SAFETY INSTRUCTIONS

## Safety instructions

These instructions are for your safety. Read them carefully.

### Insure your Rider

- Check the insurance coverage for your new Rider.
- Contact your insurance company.
- You should have fully comprehensive insurance including: third party, fire, damage, theft and liability

### General use

- Read all the instructions in this operator's manual and on the machine before you start it. Ensure you understand them and then observe them.

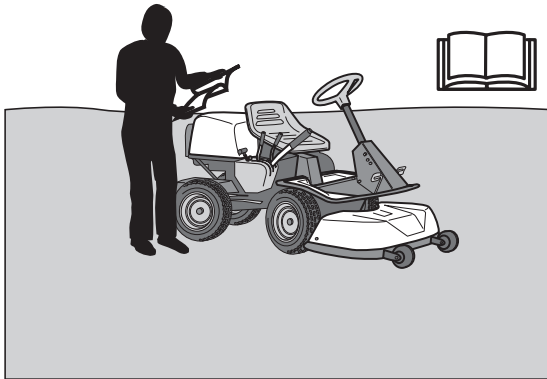

**WARNING!** This machine produces an electromagnetic field during operation. This field may under some circumstances interfere with active or passive medical implants. To reduce the risk of serious or fatal injury, we recommend persons with medical implants to consult their physician and the medical implant manufacturer before operating this machine.

- Learn how to use the machine and its controls safely and learn to how to stop quickly. Also learn to recognize the safety decals.
- Only allow the machine to be used by adults who are familiar with its use.
- Make sure nobody else is in the vicinity of the machine when you start the engine, engage the drive or drive off.
- Clear the area of objects such as stones, toys, wires, etc. that may become caught in the blades and be thrown out.



- Stop the engine and prevent the engine from being started until you have cleaned the outlet channel.
- Look out for the ejector and do not direct it towards anyone.
- Stop the engine and prevent it from starting before you clean the cutting unit.
- Remember that the driver is responsible for dangers or accidents.
- Never carry passengers. The machine is only intended to be used by one person.

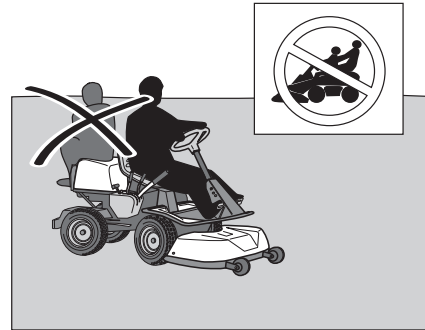

- Always look downwards and backwards before and while reversing. Keep watch for both large and small obstacles.
- Slow before cornering.
- Switch off the blades when you are not mowing.
- Take care when rounding a fixed object, so that the blades do not hit it. Never run the machine over foreign objects.



**WARNING!** This machine can sever hands and feet as well as throw objects. Failure to observe the safety instructions can result in serious injuries.



**WARNING!** The inside of the muffler contain chemicals that may be carcinogenic. Avoid contact with these elements in the event of a damaged muffler.



**WARNING!** The engine emits carbon monoxide, which is a colourless, poisonous gas. Do not use the machine in enclosed spaces.

- Only use the machine in daylight or in other well-lit conditions. Keep the machine at a safe distance from holes or other irregularities in the ground. Pay attention to other possible risks.
- Never use the machine if you are tired, if you have consumed alcohol, or if you are taking other drugs or medication that can affect your vision, judgement or coordination.
- Keep an eye on the traffic when working close to a road or when crossing it.
- Never leave the machine unsupervised with the engine running. Always stop the blades, apply the parking brake, stop the engine and remove the keys before leaving the machine.



# SAFETY INSTRUCTIONS

- Never allow children or other persons not trained in the use of the machine to use or service it. Local laws may regulate the age of the user.



**WARNING! You must use approved personal protective equipment whenever you use the machine. Personal protective equipment cannot eliminate the risk of injury but it will reduce the degree of injury if an accident does happen. Ask your dealer for help in choosing the right equipment.**

- Use hearing protection to minimise the risk of hearing impairment.



- Never wear loose fitting clothes that can catch in moving parts.
- Never use the machine when barefoot. Always wear protective shoes or protective boots, preferably with steel toes.



- Make sure that you have first aid equipment close at hand when using the machine.



## Driving on slopes

Driving on slopes is one of the operations where the risk of the driver losing control of the machine or of it overturning is the greatest; this can result in serious injury or death. All slopes demand extra care. If you cannot reverse up a slope or if you feel unsure, do not mow it.

### IMPORTANT INFORMATION

Do not drive down slopes with the unit raised.

## This is what you do

- Remove obstacles such as stones, branches, etc.
- Mow upwards and downwards, not sideways.

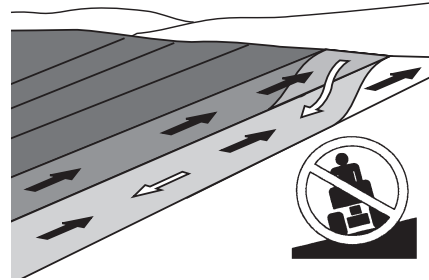

- Do not use the machine on ground that slopes more than 10°.
- Take extra care if any attachments are fitted that can change the stability of the machine.
- Avoid starting or stopping on a slope. If the tyres start to slip, stop the blades and drive slowly down the slope.
- Always drive smoothly and slowly on slopes.
- Do not make any sudden changes in speed or direction.
- Avoid unnecessary turns on slopes, if necessary, turn slowly and gradually downwards if possible. Drive slowly. Do not turn the wheel sharply.
- Watch out for and avoid driving over furrows, holes and bumps. It is easier for the machine to overturn on uneven ground. Tall grass can hide obstacles.

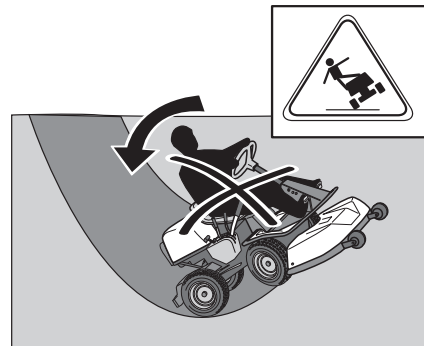

- Do not mow too close to edges, ditches or banks. The machine can suddenly overturn if one wheel comes over the edge of a steep slope or a ditch, or if an edge gives way.
- Do not mow wet grass. It is slippery, and tyres can lose their grip so that the machine skids.
- Do not try to stabilize the machine by putting your foot on the ground.
- When cleaning the chassis, the machine may never be driven near verges or ditches.
- When mowing, keep away from bushes and other objects.

# SAFETY INSTRUCTIONS

- Follow the manufacturer's recommendations regarding wheel weights or counterbalance weights to increase machine stability.

## IMPORTANT INFORMATION

Wheel weights fitted on the rear wheels are recommended when driving on slopes for safer steering and improved manoeuvrability. Consult your dealer concerning the use of wheel weights if you are unsure. Wheel weights can not be used on AWD-machines. Use counterweights.

## Children

- Serious accidents may occur if you fail to be on your guard for children in the vicinity of the machine. Children are often attracted to the machine and mowing. Never assume that children will remain where you last saw them.
- Keep children away from the area to be mowed and under close supervision by another adult.
- Keep an eye out and shut off the machine if children enter the work area.
- Before and during reversing procedures, look behind you and down for small children.
- Never allow children to ride along. They can fall off and seriously injure themselves or be in the way for safe manoeuvring of the machine.
- Never allow children to operate the machine.

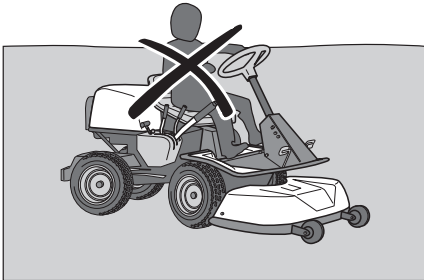

- Be particularly careful near corners, bushes, trees or other objects that block your view.

## Maintenance

- Stop the engine. Prevent starting by removing the ignition cable from the spark plug or remove the ignition key before making any adjustments or carrying out maintenance.
- Never fill the fuel tank indoors.



- Petrol and petrol fumes are poisonous and extremely flammable. Be especially careful when handling petrol, as carelessness can result in personal injury or fire.
- Only store fuel in containers approved for the purpose.
- Never remove the fuel cap and fill the fuel tank when the engine is running.
- Allow the engine to cool before refuelling. Do not smoke. Do not fill with fuel in the vicinity of sparks or naked flames.
- Handle oil, oil filters, fuel and the battery carefully, of environmental considerations. Follow the local recycling requirements.
- Electrical shocks can cause injuries. Do not touch cables when the engine is running. Do not test the ignition system with your fingers.



**WARNING! The engine and the exhaust system become very hot during operation. Risk of burn injuries if touched. When mowing, keep away from bushes and other materials in order to avoid a heating effect.**

- If leaks arise in the fuel system, the engine must not be started until the problem has been resolved.
- Store the machine and fuel in such a way that there is no risk that leaking fuel or fumes can cause any damage.
- Check the fuel level before each use and leave space for the fuel to expand, because the heat from the engine and the sun may otherwise cause the fuel to expand and overflow.
- Avoid overfilling. If you spill petrol on the machine, wipe up the spill and wait until it has evaporated before starting the engine. If you spill on your clothing, change your clothing.
- Allow the machine to cool before performing any actions in the engine compartment.
- Take care with battery maintenance. Explosive gases form in the battery. Never perform maintenance on the battery while smoking or in the vicinity of open flames or sparks. This can cause the battery to explode and cause serious injuries.

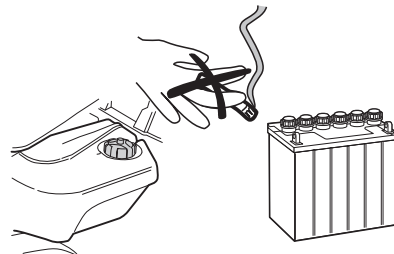

- Make sure all nuts and bolts are tightened correctly and that the equipment is in good condition.
- Do not modify safety equipment. Check regularly to be sure it works properly. The machine must not be driven if protective plates, protective covers, safety switches or other protective devices are not fitted or are defective.
- Observe the risk of injury caused by moving or hot parts if the engine is started with the engine cover open or protective cowlings removed.

---

# SAFETY INSTRUCTIONS

---

- Do not change the setting of governors. If you run too fast, you risk damaging the machine components. See chapter on Technical data for highest permitted engine speed.
- Never use the machine indoors or in spaces lacking proper ventilation. Exhaust fumes contain carbon monoxide, an odourless, poisonous and highly dangerous gas.

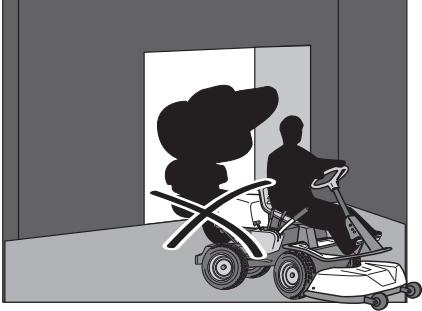

- Stop and inspect the equipment if you run over or into anything. If necessary, make repairs before starting.
- Never make adjustments with the engine running.
- The machine is tested and approved only with the equipment originally provided or recommended by the manufacturer.
- The blades are sharp and can cause cuts. Wrap the blades or wear protective gloves when handling them.
- Check regularly that the parking brake works. Adjust and maintain as required.
- Reduce the risk of fire by removing grass, leaves and other debris that may have fastened on the machine. Allow the machine to cool before putting it in storage.

## Transport

### IMPORTANT INFORMATION

The parking brake is not sufficient to lock the machine during transport. Ensure you secure the machine firmly to the transporting vehicle.

- The machine is heavy and can cause serious crush injuries. Take extra care when loading it onto or off a vehicle or trailer.
- Use an approved trailer to transport the machine.
- To secure the machine on the trailer, two approved tension belts and four wedge shaped wheel blocks should be used.

Engage the parking brake and tie the tension belts around stable parts on the machine, e.g. frame or rear wagon. Secure the machine by tensioning the belts towards the back and the front of the trailer respectively.

Place the wheel blocks in front of and behind the rear wheels.

- Check and observe local road traffic regulations before transporting or driving the machine on roads.

# PRESENTATION

## Presentation

Congratulations on your choice of an excellent quality product that will give you great pleasure for many years. This operator's manual describes Rider 316T, Rider 316Ts AWD, Rider 316TXs AWD and Rider 316T AWD.

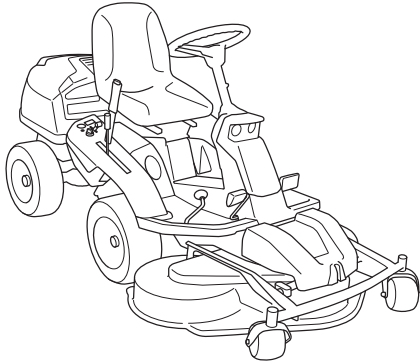

The machines are equipped with chronometer and lights.

Rider 316T AWD, 316Ts AWD, 316TXs AWD is equipped with all wheel drive.

Rider 316Ts AWD, 316TXs AWD is also equipped with power steering.

The power transmission from the engine is handled by a hydrostatic transmission, which allows variable variation of the speed by using the pedals.

One pedal for driving forward and one for reverse.

## Throttle trigger

The throttle control regulates the engine speed, and thereby also the rotation speed of the blades.

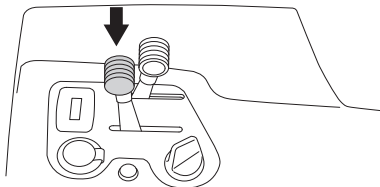

To increase or reduce the engine speed the control is moved backwards or forwards.

Avoid idling the engine for long periods, as there is a risk of carbon build-up on the spark plugs.

## Choke control

The choke lever is used for cold starting and to give the engine a richer fuel mixture.

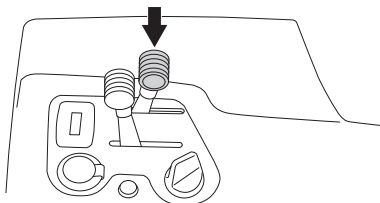

For cold starting the lever is moved backwards to its end position.

## Speed limiter

The speed of the machine is steplessly regulated with two pedals. Pedal (1) is used to drive forwards, and pedal (2) to drive backwards.

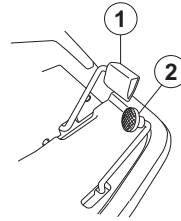

**WARNING! Make sure that branches do not obstruct the pedals when mowing under bushes. Otherwise there is a risk you may lose control.**

## Parking brake

The parking brake is applied as follows:

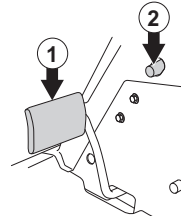

- 1 Press down the parking brake pedal (1).
- 2 Press in the lock button (2) on the steering column.
- 3 Release the parking brake pedal while keeping the button pressed in.

The parking brake lock disengages automatically when the brake pedal is pressed.

## Cutting unit

Rider 316T, Rider 316T AWD, 316TXs AWD and Rider 316Ts AWD can be equipped with three different cutting units.

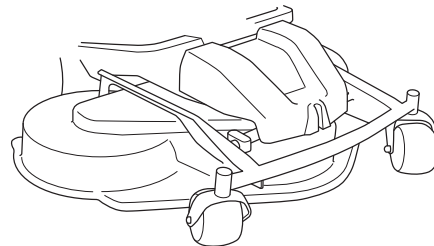

- Combi 94
- Combi 103
- Combi 112

The Combi-unit, equipped with a BioClip-plug, finely chops the cuttings to fertiliser. Without the BioClip-plug the unit works in the same way as a rear ejection unit.

# PRESENTATION

## Lifting lever for the cutting unit

The lift lever is used to set the cutting unit in transport or mowing position.

If the lever is pulled backwards the unit is raised and the blades automatically stop rotating (transport position).

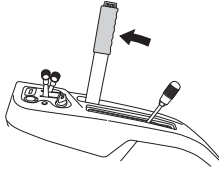

If the lock button is pressed in and the lever is moved forwards the unit will be lowered and the blades will automatically start to rotate (mowing position).

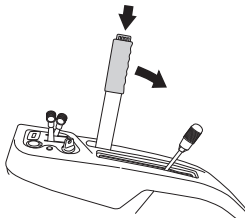

The lever can also be used to temporarily regulate the cutting height, e.g. for a small mound in the lawn.

## Cutting height adjustment lever

The cutting height can be adjusted to 10 different positions with the cutting height lever. 25-75 mm

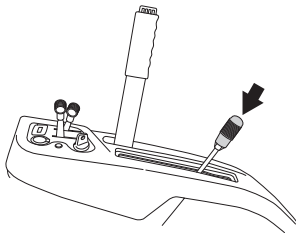

## Lights

The lights are switched on and off using the power switch on the control panel.

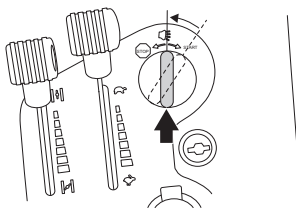

## Counter

The chronometer shows how many hours the engine has been running. Any time when the engine is not running but the ignition is switched on is not registered. The last digit shows tenths of an hour (6 minutes).

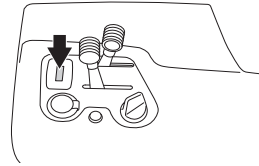

## Seat

The seat has a jointed attachment on the front edge and can be tipped forward.

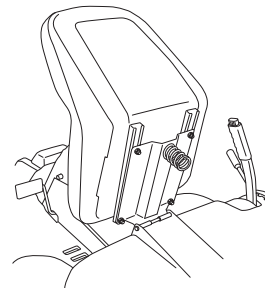

The seat can also be adjusted lengthways.

To adjust move the lever under the front edge of the seat to the left, so that the seat can be moved forward or backwards to the required position.

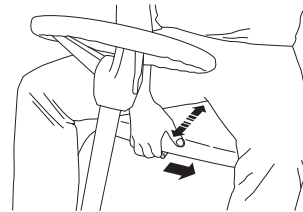

## Fueling

The engine runs on unleaded petrol with a minimum octane rating of 87 (not mixed with oil). We recommend the use of biodegradable alkylate petrol. (max. methanol 5%, max. ethanol 10%, max. MTBE 15%)

Do not fill the tank completely, leave an expansion area of at least 2.5 cm (1").

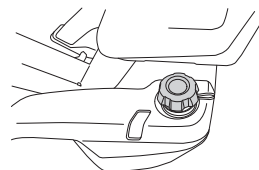

**WARNING! Petrol is highly inflammable. Exercise care and refuel outdoors (see safety instructions).**

**IMPORTANT!**

Do not use the fuel tank as a support area.

# PRESENTATION

## Release lever

The release control must be pulled out in order for the machine to be moved when the engine is shutoff.

Should you attempt to drive the machine with the clutch controls pulled out it will not move. The drive on the axle is disengaged when one of the controls is pulled out.

Pull the controls to the end positions, do not use an intermediate position.

## Clutch control Rider 316T AWD, 316TXs AWD and Rider 316Ts AWD

Rider 316T AWD, 316TXs AWD and Rider 316Ts AWD have one control for the front axle and one control for the rear axle.

### IMPORTANT!

Always drive the machine with both clutch controls pressed in.

- Clutch control, rear axle

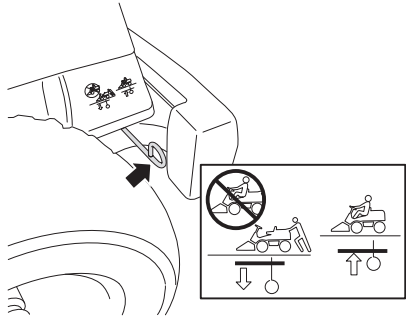

- Control drawn out, drive system disengaged.
- Control depressed, drive system engaged.

- Clutch control, front axle

The control is positioned on the inside of the left front wheel.

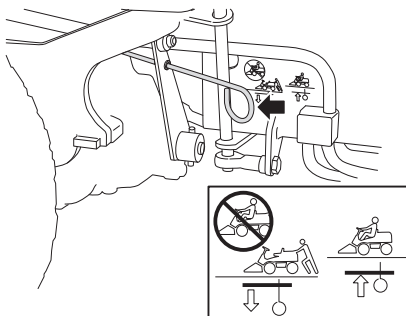

- Rear control (pulled out), drive system disengaged.
- Front control (pushed in), drive system engaged.

## Release lever Rider 316T

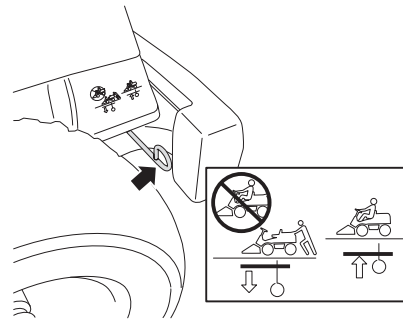

- Pull out the control to disengage the drive system.  
Push in the control to engage to the drive system.

## Before starting

- Read the safety instructions and information concerning the placement of controls and functions before starting.
- Perform daily maintenance before starting as set out in the Maintenance schedule.

### IMPORTANT INFORMATION

The air intake grille in the engine cover behind the driver's seat must not be blocked by, for example, clothing, leaves, grass or dirt. Impaired cooling of the engine.

Risk of major engine damage.

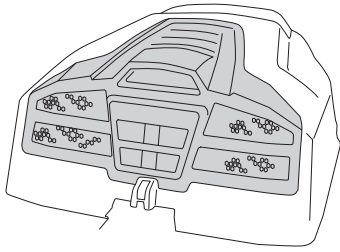

## Start the engine

- 1 Make sure that the clutch control is depressed. Rider 316T AWD, 316TXs AWD and Rider 316Ts AWD have one control for the front axle and one control for the rear axle.

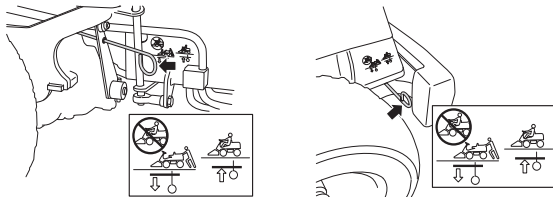

- 2 Lift up the cutting unit by pulling the lever backwards to locked position (transport position) and apply the parking brake. The engine can not be started if the parking brake is not pressed down.

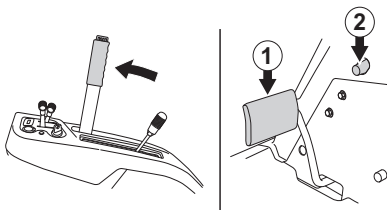

- 3 Move the throttle control to the middle position.

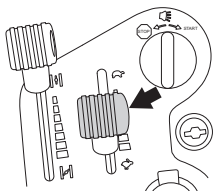

- 4 If the engine is cold move the choke lever backwards to its end position.

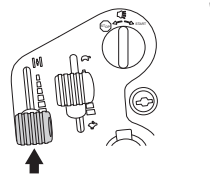

- 5 Turn the ignition key to the start position.

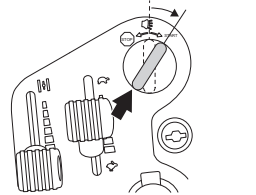

- 6 When the engine starts release the ignition key immediately back to neutral position.

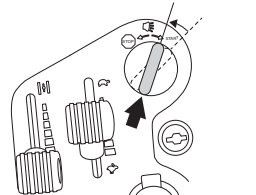

### IMPORTANT INFORMATION

Do not run the starter for more than about 5 seconds at a time. If the engine does not start, wait about 15 seconds before trying again.

- 7 Push the choke lever gradually forward when the engine has started.

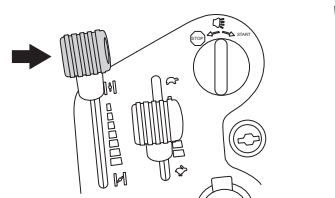

- 8 Let the engine run at moderate speed or half throttle for 3-5 minutes before subjecting it to heavy load.

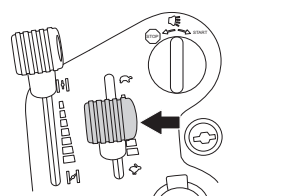

- 9 Set the required engine speed with the throttle control.



**WARNING! Never run the engine indoors, in enclosed or poorly ventilated areas. The exhaust fumes contain toxic carbon monoxide.**

## Starting the engine with a weak battery



**WARNING!** Lead-acid batteries produce explosive gases. Avoid sparks, open flames and smoking close to batteries. Always wear protective glasses in the vicinity of batteries.

If the battery is too weak to start the engine, it should be recharged.

When jump leads are used for emergency starting, follow the procedure below:

**IMPORTANT INFORMATION** Your Rider is equipped with a 12-volt system with negative earth. The other vehicle must also have a 12-volt system with negative earth. Do not use your Rider battery to start other vehicles.

## Connecting the jump leads

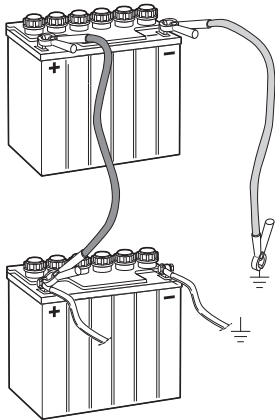

- Connect each end of the red cable to the POSITIVE pole (+) on each battery, exercise care not to short circuit any of the ends against the chassis.
- Connect one end of the black cable to the NEGATIVE pole (-) on the fully charged battery.
- Connect the other end of the black cable to a good CHASSIS EARTH, away from the fuel tank and the battery.

## Remove the cables in the reverse order

- The BLACK cable is removed from the chassis and then the fully charged battery.
- Finally the RED cable from both batteries.

**IMPORTANT INFORMATION** Never use a boost charger/start booster.

Use only conventional battery chargers. Always disconnect the charger before starting the engine. So called boost chargers/start boosters must never be used. These will often increase the voltage (instead of the current) to generate the power needed to start the engine. This increase in voltage will damage the electrical system.

## Driving the Rider

- 1 Release the parking brake by first pressing down the parking brake pedal and then releasing it.

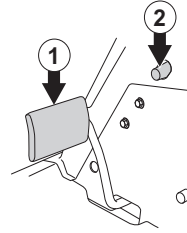

- 2 Carefully press down one of the pedals until the required speed is obtained. Pedal (1) is used to drive forwards, and pedal (2) to drive backwards.

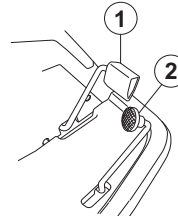

- 3 Select the required cutting height (1-10) with the cutting height lever.

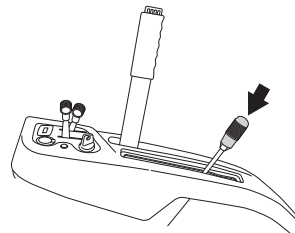

It is important that the air pressure in both front wheels is equal. 60 kPa / 0,6 bar / 8.7 PSI, to produce an even cutting height.

- 4 Press in the lock button on the lifting lever and lower the cutting unit.

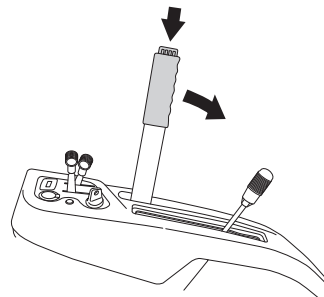

### IMPORTANT INFORMATION

The life span of the drive belts is increased significantly if the engine runs at a low speed when the blades are engaged. Therefore apply full throttle first when the cutting unit has been moved to the mowing position.



# Driving

## Cutting tips

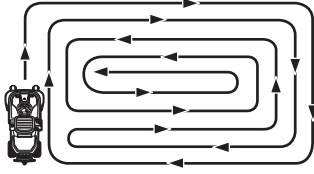

**WARNING! Clear the lawn from stones and other objects which can be thrown out by the blades.**

- Localise and mark stones and other fixed objects to avoid collision.
- Start with a high cutting height and reduce down until the required mowing results are obtained.
- The mowing result will be best with the highest permitted engine speed, see technical data, (the blades rotate rapidly) and low speed (the Rider moves slowly). If the grass is not too high and thick, the driving speed can be increased without noticeably depreciating the mowing result.
- The best lawns are achieved if the grass is cut often. Mowing becomes more uniform and the grass cuttings become more evenly distributed over the surface. The total time consumption is not greater since it is possible to select a higher driving speed without inferior mowing results.
- Avoid mowing a wet lawn. The mowing results will then be poorer.
- Hose down the cutting unit with water underneath each time it is used. The cutting unit should then be put in the service position.
- When the BioClip function is used, it is very important that the mowing interval is not too long.



**WARNING! Do not use the machine on ground that slopes more than 10°. Mow slopes upwards and downwards, never across. Avoid sudden changes in direction.**

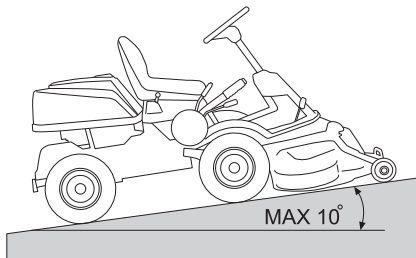

## Stop the engine

Preferably allow the engine to idle for a minute to obtain normal working temperature before stopping it if it has been working hard. Avoid idling the engine for long periods, as there is a risk of carbon build-up on the spark plugs.

- 1 Lift up the cutting unit by pulling the lever backwards to its locked position.

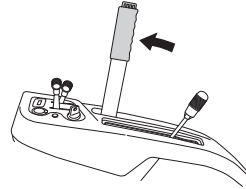

- 2 Move the throttle to the idle position. Turn the ignition key to the "STOP".

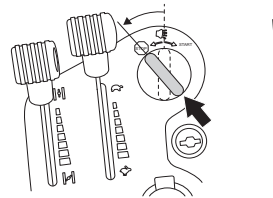

- 3 When the Rider is at a standstill, press down the parking brake and push in the locking button.

# Maintenance

## Maintenance schedule

The following is a list of the maintenance which should be conducted on the machine. For those points not described in this manual, visit an authorised service workshop.

Maintenance	Daily maintenance before starting	At least once a year	Maintenance interval in hours			
			25	50	100	200
Cleaning	X					
Check the engine's oil level	X					
Check the engine's cooling air intake	X					
Check the fuel pump air filter	X					
Check the steering wires	X					
Check the battery	X					
Check the safety system	X					
Check nuts and screws	O					
Check for fuel and oil leakage.	O					
Clean around the silencer	O					
Clean the prefilter in the air filter <sup>2)</sup>			X			
Change the engine oil <sup>3, 4)</sup>				X <sup>3</sup>	X <sup>3</sup>	
Check the cutting deck			X			
Check the air pressure in the tyres, 60 kPa/8.5 PSI.			X			
Lubricate the belt adjuster <sup>1)</sup>			X			
Lubricate joints and shafts <sup>1)</sup>			X			
Adjust the brake				X		
Check the V-belts			O			
Check the cooling fins on the hydrostatic transmission			O			
Checking the transmission oil level	X					
Checking and adjusting the choke wire				X		
Tighten the nuts and screws					O	
Checking and adjusting of throttle wire				X		
Clean the cooling fins on the engine and hydrostatic transmission <sup>2)</sup>				O		
Replace the air filter's prefilter and paper filter <sup>2, 5)</sup>					X	X
Replace the fuel filter					X	
Replace the spark plug.					X	
Check the engine valve clearance <sup>6)</sup>						
Check the need to change the oil <sup>6, 7)</sup> in the gearbox/hydraulic system		O				O
Change the oil filter						X
Clean the combustion chamber <sup>6)</sup>						
Decarburization and valve grinding <sup>6)</sup>						
Check the synchronisation between the front and rear wheels.		O				
Check the fuel hose. Replace if necessary . <sup>6)</sup>		O				

<sup>1)</sup>If the machine is used daily it should be lubricated twice a week. <sup>2)</sup> Maintenance and replacement are required more often in dusty conditions. <sup>3)</sup>First change after 8 hours. When operating with a heavy load or at high ambient temperatures, replace every 50 hours. <sup>4)</sup>Replace the oil filter every 200 hours. <sup>5)</sup>Replace the paper filter annually or every 200 hours. <sup>6)</sup>Conducted by authorised service workshop. <sup>7)</sup>Only 316T AWD, 316Ts AWD, 316TXs AWD first change after 8 hours

X = Described in this operator's manual

O = Not described in this operator's manual



**WARNING! No service procedures must be conducted on the engine or cutting unit unless:**

- The engine is switched off.**
- The parking brake is applied.**
- The ignition key is removed.**
- The cutting unit is disengaged.**
- The ignition cables are removed from the plugs.**

# Maintenance

## Cleaning

Clean the machine directly after use. It is much easier to wash off grass cuttings before they dry.



Oily dirt can be removed using a cold degreasing agent. Spray on a thin layer.

Rinse at normal water pressure.

Do not direct the jet towards electrical components or bearings.

Do not rinse hot surfaces such as the engine and exhaust system.

It is recommended that you start the engine and run the mower for a short period after cleaning, so that any remaining water is blown off.

Lubricate the machine if necessary after cleaning. Carry out extra lubrication when the bearings have been exposed to a degreaser or a water jet.

### IMPORTANT INFORMATION

Avoid using a high pressure washer or a steam cleaner. There is a major risk of water penetrating into bearings and electrical connections. Corrosion attack can result, which will lead to running problems. Cleaning additives generally aggravate the damage.

## Removing of the machine hoods

### Engine cover

The engine becomes accessible for service when the engine cover is opened.

Fold the seat forward, loosen the snap lock under the seat and fold the cover backwards.

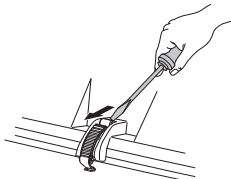

### Front cover

Release the clip on the front hood and lift off the fender.

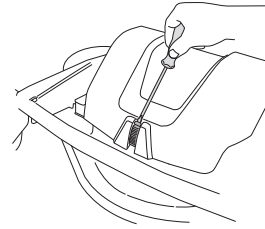

### Right-hand fender

Remove the accelerator knob (1), screws (2 and 3), and remove the cover.

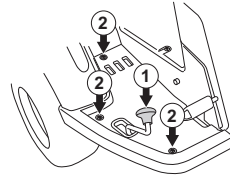

### Left-hand fender

Remove the screws holding the wing cover (2) and lift off the cover.

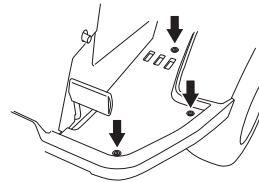

## Checking and adjusting the steering wires

The steering is controlled by means of wires.

These can in time become slack, which implies that the adjustment of the steering becomes altered.

Check and adjust the steering as follows:

- 1 Remove the frame plate by loosening the screws (2) and lift the frame plate by the rear edge.

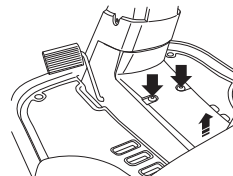

# Maintenance

- 2 Check the tension of the steering wires by squeezing them together by the arrows as illustrated. It should be possible to push them together so that the distance between them is half as much, without using unnecessary force.

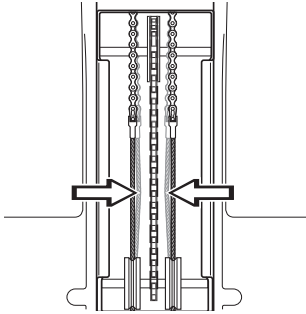

- 3 If necessary, the wires can be adjusted by tightening the adjuster nuts on each side of the steering collar. Do not over tighten the cables; they should only be drawn in towards the steering collar.

Hold the cable, for example using an adjustable wrench, so that it does not twist.

If the adjustment is only made on one side, the middle position of the steering will be affected.

Check the wire tension on completion of the adjustment as per item 2.

## Adjusting the parking brake Rider 316T

The parking brake is adjusted as follows:

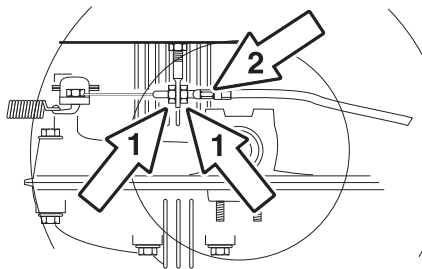

- 1 Loosen the locking nuts (1).
- 2 Tension the cable using the adjuster screw (2) until the play in the cable is taken up.
- 3 Tighten the locking nuts (1) after adjustment.
- 4 The parking brake should be checked again after the adjustment has been made.

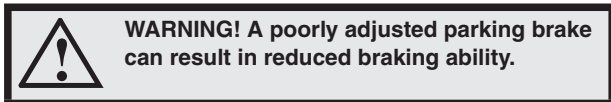

**WARNING! A poorly adjusted parking brake can result in reduced braking ability.**

## Adjusting the parking brake Rider 316T AWD, Rider 316TXs AWD and Rider 316Ts AWD

Check that the parking brake is adjusted correctly by placing the machine on a slope with the front and rear axles disengaged.

Apply and lock the parking brake. When the machine does not stand still, the parking brake should be adjusted according to the following.

- 1 Remove the left-hand wing cover.

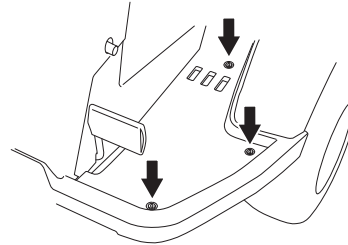

- 2 Loosen the locking nuts (1).

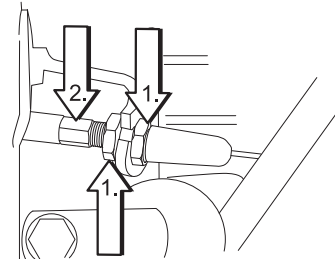

- 3 Tension the cable using the adjuster screw (2) until the play in the cable is taken up.
- 4 Tighten the locking nuts (1).
- 5 The brake should be checked again after adjustment.
- 6 Assemble the left-hand wing cover.

## Checking and adjusting of throttle wire

Check that the engine responds to the throttle control and that the correct engine speed is achieved at full throttle.

If doubts arise, contact your service representative.

If adjustment is necessary, adjust the lower wire as follows:

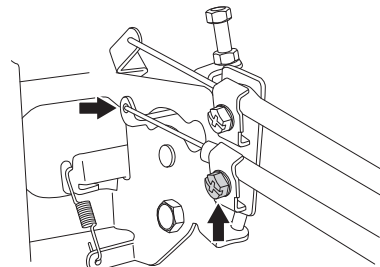

- 1 Loosen the clamping screw for the cable's outer casing and move the throttle to the full throttle position.
- 2 Check that the throttle wire is attached to the correct hole in the lower lever, see diagram.
- 3 Pull the throttle wire casing to the far left and tighten the clamping screw.

# Maintenance

## Checking and adjusting the choke wire

If the engine is producing black smoke or is difficult to start then the choke wire (upper wire) may be incorrectly adjusted.

If doubts arise, contact your service representative.

If it is necessary to adjust the choke, proceed as follows:

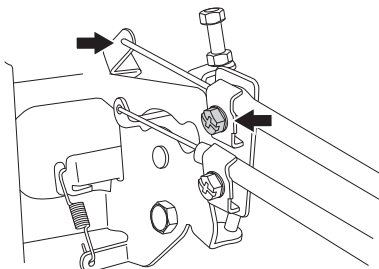

- 1 Release the clamping screw that secures the wire casing and set the choke control to maximum choke.
- 2 Check that the throttle wire is attached to the upper lever, see diagram.
- 3 Pull the choke wire casing to the far right and tighten the clamping screw.

## Replacement of fuel filter

Replace the fuel filter every 100 running hours (once per season) or more frequently if it is clogged.

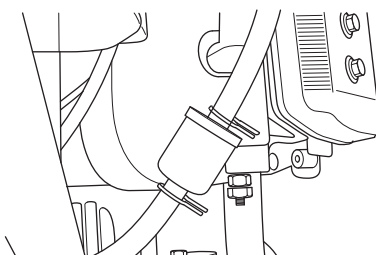

Replace the filter as follows:

- 1 Open the engine cover.
- 2 Move the hose clips away from the filter. Use a pair of flat pliers.
- 3 Pull off the filter from the hose ends.
- 4 Press the new filter into the ends of the hoses. If necessary apply liquid detergent to the ends of the filter to facilitate connection.
- 5 Push the hose clips back on the filter and tighten.

## Checking the fuel pump's air filter

Check regularly that the fuel pump's air filter is free from dirt.

The filter can when necessary be cleaned with a brush.

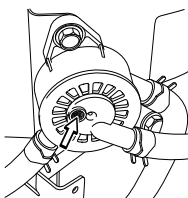

## Replacing the air filter



**WARNING! The exhaust system is hot. Let it cool before starting to replace the air filter.**

If the engine seems to lack power or does not run smoothly this may be because the air filter is clogged. It is therefore important to replace the air filter at regular intervals (see Maintenance/Maintenance Schedule for the correct service interval).

Replace the air filter as follows:

- 1 Loosen the knobs holding the filter cover in place and remove it.

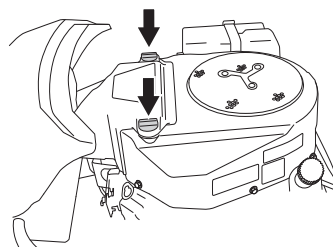

- 2 Loosen the hose clip that holds the filter cartridge.

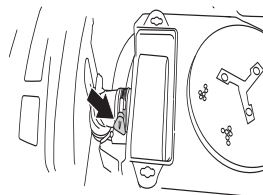

- 3 Remove the filter cartridge from the filter housing.

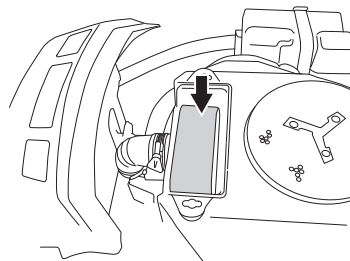

### IMPORTANT INFORMATION

Never run the engine without the air filter fitted.

The filters must not be oiled. They must be fitted dry.

- 4 Remove the foam rubber prefilter which is placed around the filter cartridge and clean using a mild detergent.
- 5 Dry the pre-filter properly.
- 6 Clean the filter by knocking it with care against a hard surface. Do not use compressed air to clean the filter. Replace the air filter if it is still dirty.  
Always replace the paper filter every 200 hours.
- 7 Refit the pre-filter on the paper filter.

# Maintenance

- Pull the filter over the air hose and clamp the filter cartridge in place with a hose clip.

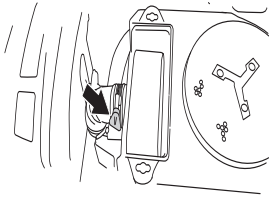

- Refit the air filter cover.

## Ignition system

The engine is equipped with an electronic ignition system. Only the spark plug requires maintenance.

For recommended spark plug, see Technical data.

### IMPORTANT INFORMATION

Fitting the wrong spark plug type can damage the engine.

## Replacing the spark plug

- Remove the ignition cable shoe and clean around the spark plug.
- Remove the spark plug with a 3/4" (19 mm) spark plug socket wrench.
- Check the spark plug. Replace the spark plug if the electrodes are burned or if the insulation is cracked or damaged. Clean the spark plug with a steel brush if it is to be reused.
- Measure the electrode gap with a gapping tool. The gap should be 0.75 mm/0.030". Adjust as necessary by bending the side electrode.
- Reinsert the spark plug, turning by hand to avoid damaging the threads.
- Tighten the spark plug, once it touches the seating, with the spark plug spanner. Tighten the spark plug so that the washer is compressed. A used spark plug should be turned 1/8 of a turn from the seated position. A new spark plug should be turned a 1/4 turn from the seated position.
- Replace the ignition cable shoe.

### IMPORTANT INFORMATION

Inadequately tightened spark plugs can cause overheating and damage the engine. Tightening the spark plug too much can damage the threads in the cylinder head.

## Check the safety system

The machine is equipped with a safety system that prevents starting or driving under the following conditions.

The engine can only be started when:

- The cutting deck is raised and the parking brake is applied.

The engine should stop when:

- The cutting deck is lowered and the driver rises from the seat.
- The cutting deck is in its raised position, the parking brake is not applied and the driver rises from the seat.

Check daily to ensure that the safety system works by attempting to start the engine when one of the conditions above is not met. Change the conditions and try again.

## Replacing the light bulbs

For information about the bulb type, see Technical Data.

- Unscrew the two screws holding the cover on the power servo housing. One screw on each side.

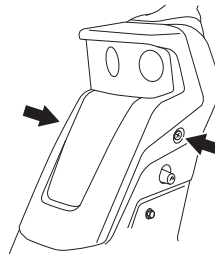

- Disconnect the cables from the bulbs.

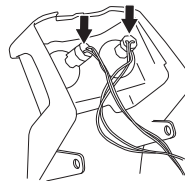

- Gently push in the locking mechanism and fold out the lamps from their brackets.

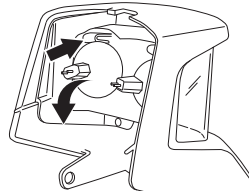

- Insert the new lamps in the lower slot on the lamp housing.

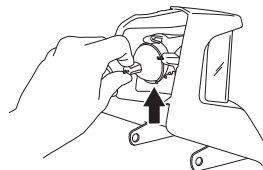

# Maintenance

- 5 Press the lamp in place in the locking bracket

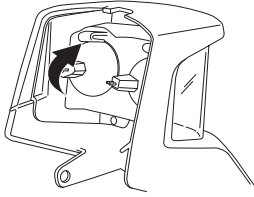

- 6 Fit the lamp holder in the lower slots on the servo housing.

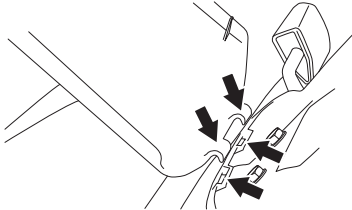

- 7 Refit the cables and screw the lamp holder on to the servo housing.

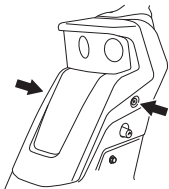

## Main fuse

The main fuse is placed in a detachable holder under the battery case's cover, in front of the battery.

Type: Flat pin, 15 A.

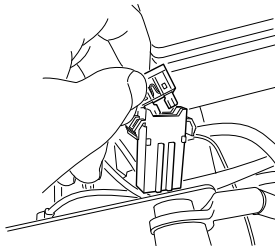

Do not use any other type of fuse when replacing.

A blown fuse is indicated by a burnt connector. Pull the fuse from the holder when replacing.

The fuse is there to protect the electrical system. If it blows again shortly after replacement, it is due to a short circuit, which must be fixed before the machine can be put into operation again.

## Checking the tyre pressure

The tyre pressure should be 60 kPa (0.6 bar / 9 PSI) all round. To improve driving the pressure on the rear tyres can be reduced to 40 kPa (0.4 bar/5.6 PSI). The maximum tyre pressure is 100 kPa (1,0 bar/14 PSI).

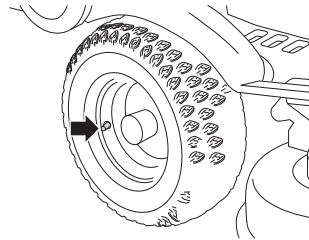

### IMPORTANT INFORMATION

Having the same air pressure in the tyres is important in order to achieve the best possible performance as well as to avoid damage to the machine

## Checking the engine's cooling air intake

Clean the air intake grille in the engine cover behind the driver's seat.

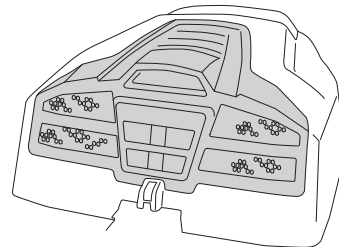

Open the engine cover.

Check that the cooling intake is free from leaves, grass and dirt.

A blocked cooling intake will interfere with the cooling of the engine, which can damage the engine.

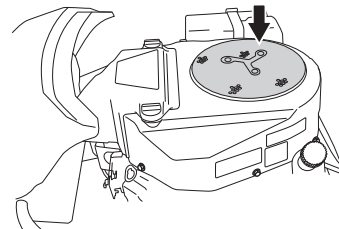

**WARNING!** The cooling air intake rotates when the engine is running. Mind your fingers.

# Maintenance

## Fitting the cutting head



**WARNING!** Wear protective glasses when fitting the cutting unit. The spring which tensions up the belt may break and cause personal injury.

- 1 Place the Rider on a flat surface and apply the parking brake.
- 2 Check that the lever for setting the cutting height is in the lowest position and that the lifting lever for the cutting unit is in mowing position.

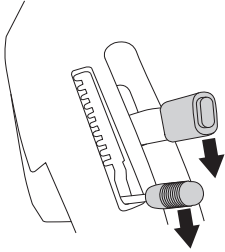

- 3 Push the equipment frame down and place the catch against the frame.

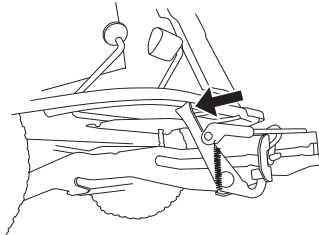

- 4 Engage the belt in the belt holder.

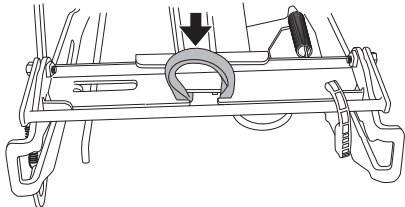

- 5 Push the deck in and put the front guide plugs in the grooves on the equipment frame, one on each side.

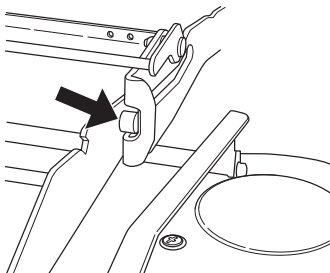

**WARNING!** Observe caution to avoid trapping your hand.

- 6 Lift up the cutting unit

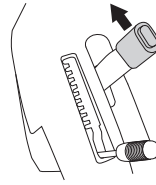

- 7 Push the unit in so that the interior plugs touch the bottom of the equipment frame's grooves.

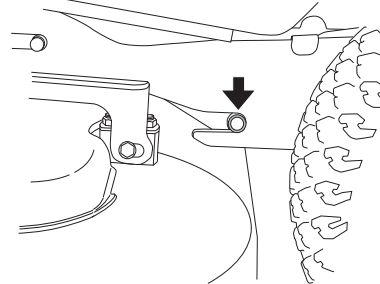

- 8 Fit the drive belt around the drive wheels of the cutting unit. Make sure the belt is placed on the correct side of the belt tensioner wheel.

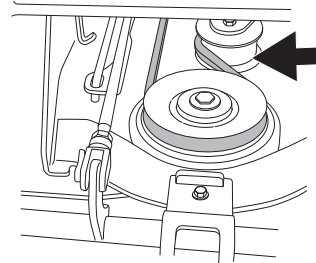

- 9 Hook up the height adjustment strut.

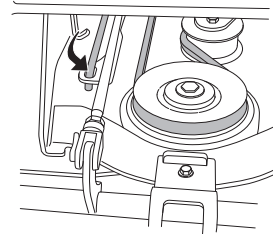

- 10 Secure the collet spring.

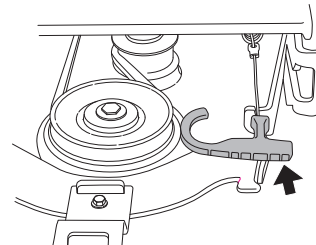

- 11 Fit the front cover.



# Maintenance

## Removing the cutting unit



**WARNING! Wear protective glasses when dismantling the cutting unit. The spring which tensions up the belt may break and cause personal injury.**

- 1 Carry out points 1-6 to put the cutting unit in the service position, see Service position for the cutting unit.
- 2 Lower the cutting unit.

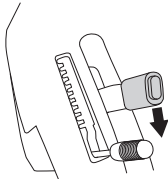

- 3 Open the unit catch.

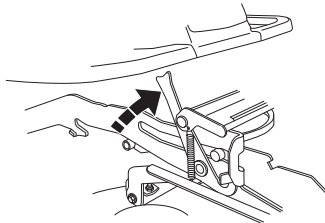

- 4 Pull out the cutting unit.

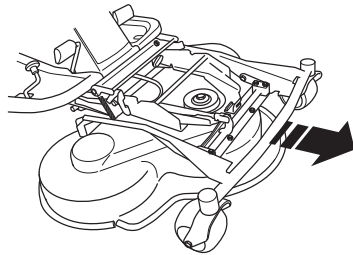

**WARNING! Observe caution to avoid trapping your hand.**

## Checking and adjustment of the cutting unit's ground pressure

To achieve the best cutting results the cutting unit should follow the underlying surface without pressing too hard against it.

Pressure is adjusted using a screw and spring on each side of the Rider.

- 1 Check the air pressure in the tyres 60 kPa/0.6 kp/cm<sup>2</sup>/8.5 PSI.
- 2 Place the machine on a flat surface.
- 3 Put the lifting lever in the mowing position.

- 4 Place a set of bathroom scales under the cutting unit's frame (front edge) so that it rests on the scales. If necessary a block can be placed between the frame and scales so that the support wheels do not bear any weight.

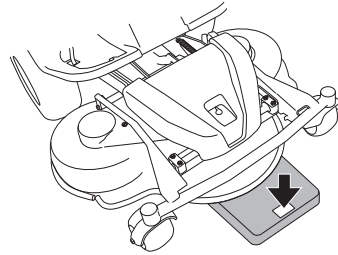

- 5 Adjust the unit's ground pressure by screwing in or out the adjusting screws located behind the front wheels on both sides. The ground pressure should be between 12 and 15 kg (26.5-33 lb).

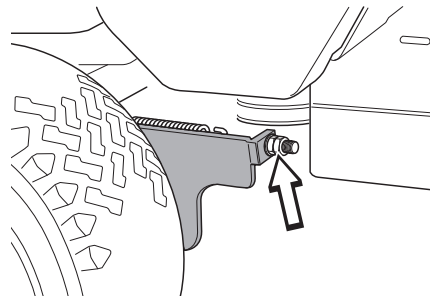

## Checking the cutting unit's parallelism

Check the cutting unit's parallelism as follows:

- 1 Check the air pressure in the tyres 60 kPa/0.6 kp/cm<sup>2</sup>/8.5 PSI.
- 2 Place the machine on a flat surface.
- 3 Put the lifting lever in the mowing position.
- 4 Measure the distance between the ground and the front and rear edges of the cutting unit hood. The cutting unit should have a slight slant, with the rear edge 2-4 mm (1/8") higher than the front edge.

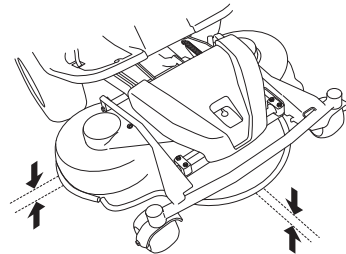

# Maintenance

## Adjusting the parallelism of the cutting unit

- 1 Remove the front hood and right-hand fender.
- 2 Undo the nuts on the lift strut.

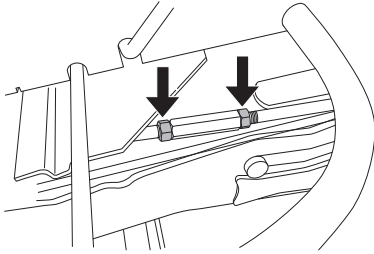

- 3 Screw out (extend) the stay to raise the rear edge of the cover.  
Screw in (shorten) the stay to lower the rear edge of the cover.

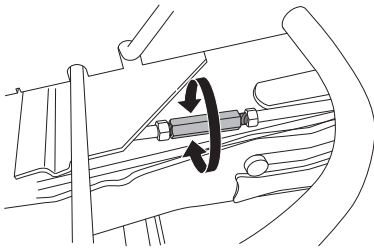

- 4 Tighten the nuts after adjustment.
- 5 On completion of the adjustment the unit's parallelism should be re-checked.
- 6 Fit the right-hand fender and the front hood.

## Replacing the cutting unit belts



**WARNING! Wear gloves to protect your hands when working with the blades.**

**There is a risk of crush injuries when working with the belt.**

On these cutting units with collision-proof blades, the blades are driven by one V-belt. Do as follows to change the V-belt:

- 1 Remove the cutting unit.
- 2 Open the lock for the track rod bolt.

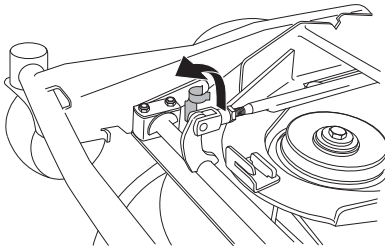

- 3 Unscrew the bolts holding the unit frame bracket.

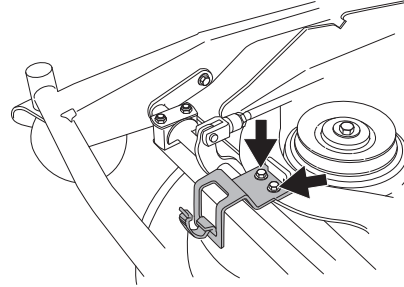

- 4 Remove the lock and pass the unit frame out.
- 5 Remove the two bolts on the unit frame.

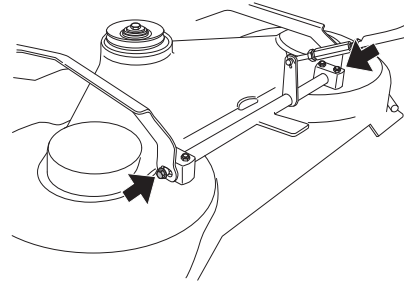

- 6 Remove the bolt so the track rod is released in one end.

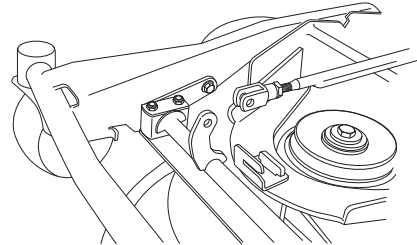

- 7 Remove the screws on the cutting cover. Lift the unit frame and remove the cutting unit cover.

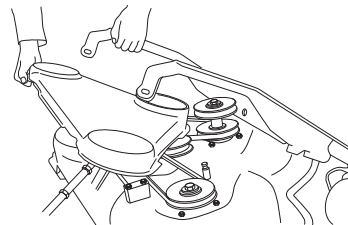

- 8 Loosen the spring that tensions the V-belt and pry off the belt.

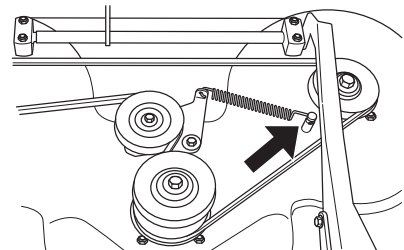

Assemble the parts in the reverse order.

# Maintenance

## Service position for the cutting unit

The cutting head can be placed in the service position to provide easy access for cleaning, repairs and servicing. In the service position the cutting unit is raised and locked in the vertical position.

### Placing in the service position

- 1 Position the machine on flat ground. Apply the parking brake.
- 2 Set the cutting height control in the lowest position and lift up the cutting unit.

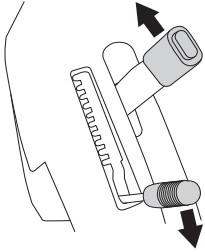

- 3 Remove the front cover.

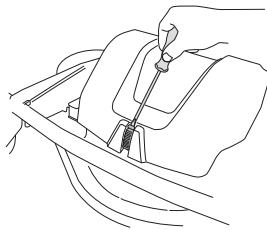

**WARNING!** Wear protective glasses when dismantling the cutting unit. The spring which tensions up the belt may break and cause personal injury.

- 4 Disengage the spring for the drive belt tensioning wheel.

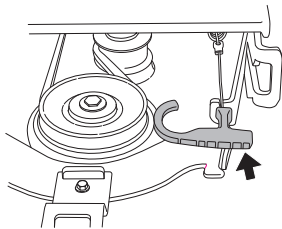

- 5 Loosen on the cutting height stay and place in the holder.

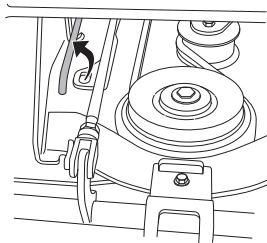

**WARNING!** Observe caution to avoid trapping your hand.

- 6 Remove the drive belt and place it in the belt holder.

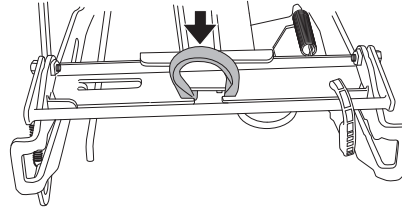

- 7 Grip the front edge of the unit and pull forwards until it stops.

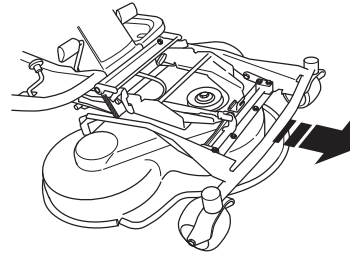

- 8 Lift the unit until it stops and a clicking sound is heard. The unit locks automatically in the vertical position.

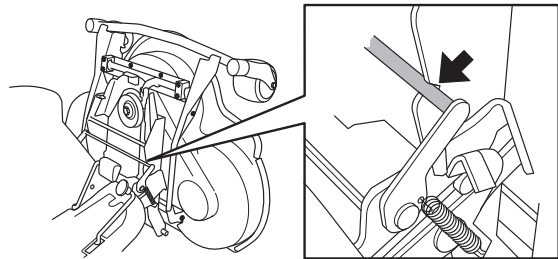

### Restoring from service position

- 1 Grip the front edge of the unit and loosen the lock, fold down and slide in the unit.
- 2 Replace the cutting height stay and the belt.

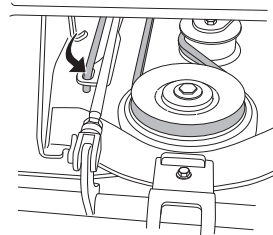

- 3 Tension the belt with the belt adjuster.

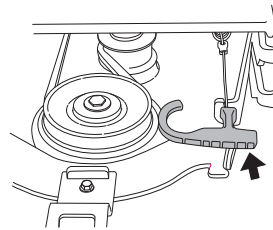

- 4 Fit the front cover.

# Maintenance

## Checking the blades

To achieve the best mowing results it is important that the blades are undamaged and well-sharpened.

Check that the blades' attachment screws are tight.

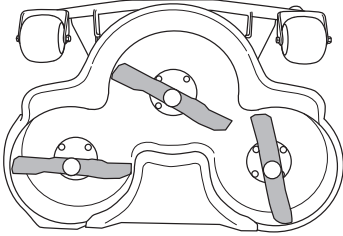

**IMPORTANT INFORMATION** Replacing or sharpening the blades should be conducted by an authorised service workshop.

The blades should be balanced after sharpening.

Damaged blades should be replaced when hitting obstacles that result in a breakdown. Let the service centre assess whether the blade can be sharpened or must be replaced.

## Removing the BioClip plug

To change a Combi unit from BioClip function to cutting unit with rear ejection, remove the BioClip plug located under the unit with three screws.

### Combi 103, Combi 112

- 1 Put the unit in the service position, see Placing in the service position.
- 2 Remove the three screws holding the BioClip plug, and remove the plug.

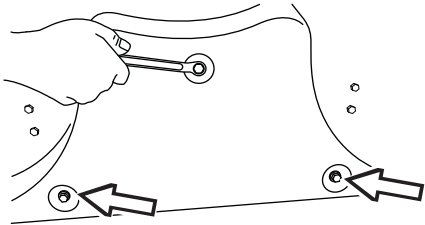

- 3 **Tip:** Fit three full-thread screws M8x15 mm in the screw holes to protect the threads.
- 4 Replace the unit in normal position.  
Fit the BioClip plug in the reverse order.

### Combi 94

- 1 Put the unit in the service position, see Service position for the cutting unit.
- 2 Loosen the knob and the bolts holding the BioClip plug and remove the plug.

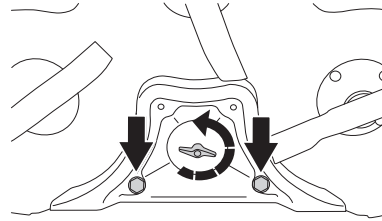

- 3 Replace the unit in normal position.

# Lubrication

## Checking the engine's oil level.

Check the oil level in the engine when the Rider stands horizontal with the engine switched off.

Open the engine cover.

Loosen the dipstick, pull it up and wipe it off.

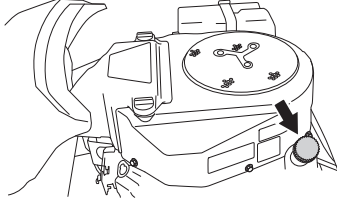

Now insert the dipstick again, **without tightening it**.

Pull the dipstick out again and read the oil level.

The oil level should be between the markings on the dipstick. If the level is approaching the ADD mark, top up the oil to the FULL mark on the dipstick.

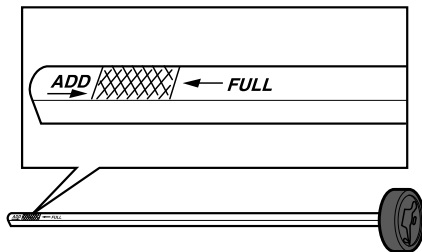

The oil is topped up through the hole the dipstick sits in. Fill the oil slowly.

Tighten the dipstick correctly before starting the engine. Start and run the engine at idling speed for approx. 30 seconds. Turn off the motor. Wait 30 seconds and check the oil level. If necessary fill so that the oil comes up to the FULL mark on the dipstick.

The following oil classes are recommended:

- API Service Class: SF, SG, SH and SJ

Choose an oil with viscosity according to the temperature ranges in the figure:

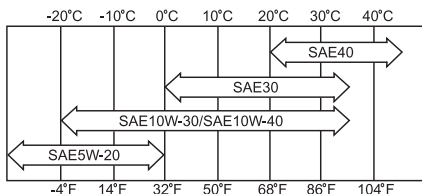

Do not mix different types of oil.

## Replacing the engine oil

The engine oil should be changed the first time after 8 hours running time. It should then be changed after every 100 hours of running time.

When operating with a heavy load or at high ambient temperatures, replace every 50 hours.



**WARNING! Engine oil can be very hot if it is drained directly after stopping the engine. Allow the engine to cool somewhat first.**

- 1 Place a container underneath the engine's left oil drain plug.

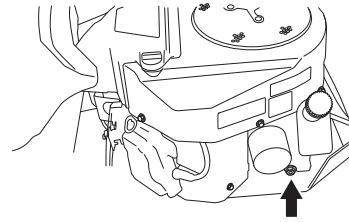

- 2 Remove the dipstick. Remove the drain plug from the engine's left side.
- 3 Let the oil run out into the container.
- 4 Fit the drain plug and tighten it.
- 5 If necessary fill so that the oil comes up to the FULL mark on the dipstick. The oil is topped up through the hole the dipstick sits in. See Checking the engine's oil level for filling instructions. The engine holds 1.5 litres (1.6 USqt) when the oil filter is not replaced and 1.7 litres (1.8 USqt) of oil when the oil filter is replaced.
- 6 Run the engine warm, then check that there is no leakage from the oil plug.

### IMPORTANT INFORMATION

Used engine oil, antifreeze etc. is a health hazard and must not be disposed of on the ground or in nature; it should always be disposed of at a workshop or appropriate disposal location.

Avoid skin contact; wash with soap and water in case of spills.

## Changing the oil filter

The oil filter must be replaced after every 200 hours running time. Turn the old oil filter anti-clockwise to remove. If necessary, use a filter remover.

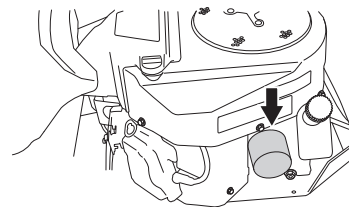

Lightly lubricate the rubber seal on the new oil filter using new oil. Fit the oil filter by turning clockwise. Turn by hand until the rubber seal is seated. Now tighten a further half turn.

Fill with new oil according to Checking the engine's oil level. Start the engine and let it idle for about 3 minutes. Now stop it and check for signs of leakage. Fill with oil to compensate for the oil held in the new oil filter.

# Lubrication

## Checking the transmission oil level

- 1 Remove the transmission cover. Undo the two screws (one on each side) and lift off the transmission cover.

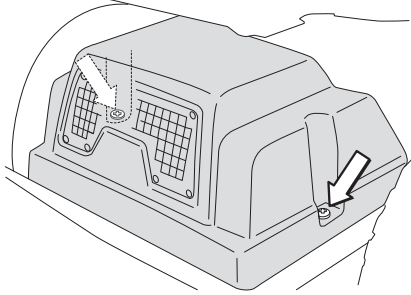

- 2 Check that there is oil in the transmission's oil tank.

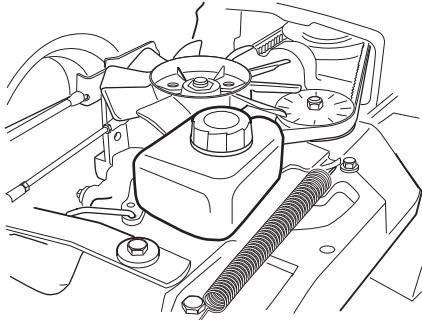

**Rider 316T** Fill if necessary with engine oil SAE 10W/40 (class SF-CC).

**Rider 316T AWD, 316Ts AWD, 316TXs AWD** Fill if necessary with oil Synthetic 10W/50

The oil and filter should be changed by an authorised service representative, as described in the Workshop Manual.

Work on the system entails particular demands on cleanliness and the system must be vented before the machine is used.

## Lubricating the belt adjuster

The belt adjuster should be lubricated regularly using good quality molybdenum disulphide grease\*.

Lubricate using a grease gun, 1 nipple from the right-hand side under the engine's lower belt pulley, until grease is forced out.

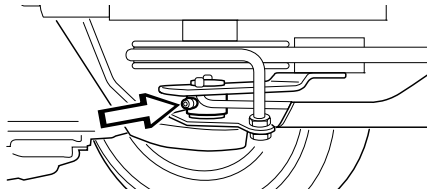

With daily use, lubrication should be carried out twice weekly.

## General lubrication

All joints and bearings are lubricated using molybdenum disulphide grease during manufacture. Continue to lubricate using the same type of grease \*. Lubricate the steering and control wires using engine oil.

Carry out this lubrication regularly; with daily use, the machine should be lubricated twice weekly.

\*Grease from well-known brand names (petrochemical companies, etc.) usually maintains a good quality. The most important property is that the grease provides good protection against corrosion.

---

# Troubleshooting schedule

---

<b>Problem</b>	<b>Procedure</b>
<b>Engine does not start</b>	There is no fuel in the fuel tank Spark plug defective Faulty spark plug connections or interchanged cables Dirt in the carburettor or fuel line Starter motor does not turn over the engine
<b>Starter motor does not turn over the engine</b>	Battery flat Bad contact between the cable and battery Lift lever for cutting unit in wrong position Main fuse blown. Ignition lock faulty Brake not activated. Faulty starter motor
<b>Engine does not run smoothly</b>	Faulty spark plug. Carburettor incorrectly set Air filter clogged Fuel tank vent blocked Ignition key defective Dirt in the carburettor or fuel line Choking or incorrectly adjusted throttle cable
<b>Engine seems to have no power</b>	Air filter clogged Spark plug defective Dirt in the carburettor or fuel line Carburettor incorrectly set Choking or incorrectly adjusted throttle cable
<b>Engine overheats</b>	Engine overloaded Spark plug defective Air intake or cooling flanges blocked Fan damaged Too little or no oil in engine Ignition defective
<b>Battery does not charge</b>	One or more battery cells faulty Poor contact on the battery terminal cable connectors
<b>Machine vibrates</b>	Blades are loose Engine is loose One or more blades unbalanced, caused by damage or poor balancing after sharpening
<b>Uneven mowing</b>	Blades blunt Long or wet grass Cutting unit skew Grass blockage under hood Different tyre pressures on right and left sides Over-speeding Engine speed too low Drive belt slipping

# Storage

## Winter storage

At the end of the season, or if the machine is going to stand idle for more than 30 days, it should immediately be made ready for storage. Fuel which is left to stand for long periods (30 days or more) can leave tacky deposits which can block the carburettor and interfere with the engine.

Fuel stabiliser is an acceptable alternative to avoid tacky deposits during storage. If alkylate petrol (Aspen) is used stabiliser is not necessary since this fuel is stable. However, one should avoid changing from standard to alkylate petrol since sensitive rubber parts can harden. Add stabiliser to the fuel in the tank or the storage container. Always use the mixing ratios indicated by the manufacturer. Run the engine for at least 10 minutes after adding the stabiliser so that it will reach the carburettor. Do not empty the fuel tank and carburettor if stabiliser has been added.



**WARNING! Never store a machine with fuel in the tank indoors or in poorly ventilated spaces where fuel vapour can come in contact with open flames, sparks, or a pilot light such as in a boiler, hot water tank, clothes drier, etc. Exercise caution when handling fuel. It is highly inflammable, and careless use can cause serious injury and damage to property. Drain off the fuel in an approved container outdoors and well clear of naked flames. Never use petrol for cleaning purposes. Use degreasing agents and hot water instead.**

To prepare the machine for storage follow these instructions:

- 1 Carefully clean the machine, especially under the cutting unit. Touch-up paint damage to avoid rust.
- 2 Inspect the machine for worn or damaged parts and tighten loose screws and nuts.
- 3 Change the engine oil, and take care of the waste oil.
- 4 Empty the fuel tank. Start the engine and run it until the carburettor is emptied of fuel.
- 5 Remove the plugs and pour about a tablespoon of engine oil into each cylinder. Pull round the engine to distribute the oil and screw the plugs back on.
- 6 Grease all grease nipples, joints and axles.
- 7 Remove the battery. Clean it, charge it, and store it in a cool place.
- 8 Store the machine in a clean and dry place and cover it over for extra protection.

## Guard

There is a cover to protect your machine during storage or transport. Contact your dealer for a demonstration

## Service

Low season is the most suitable time to perform a service or overhaul of the machine in order to ensure high function safety during high season.

When ordering spare parts state your machine's purchase year, model, type, and serial number.

Always use genuine parts.

Annual inspection or tuning by an authorised service workshop is a good way of getting the best out of your machine the next season.

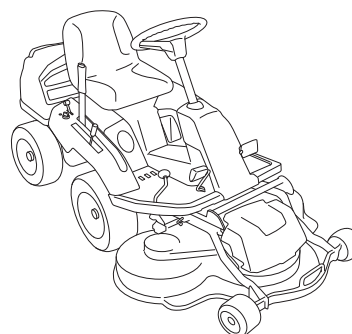



# Technical data

<b>Dimensions</b>	<b>Rider 316T</b>	<b>Rider 316T AWD</b>
Length without cutting unit, mm/ft	2020/6,61	2020/6,61
Width without cutting unit, mm/ft	890/2,92	890/2,92
Height, mm/ft	1150/3,77	1150/3,77
Operating weight with cutting deck, kg/lb	275-280-283/606-617-624	294-299-302/648-659-666
Wheel base, mm/ft	887/2,91	887/2,91
Track width, front, mm/ft	712/2,34	712/2,34
Track width, rear, mm/ft	627/2,06	627/2,06
Tyre dimensions	16 x 6,50 x 8	16 x 6,50 x 8
Air pressure, rear - front, kPa / bar / PSI	60 (0,6/8,5)	60 (0,6/8,5)
<b>Engine</b>		
Brand / Model	Kawasaki / FS481V	Kawasaki / FS481V
Nominal engine output, kW (see note 1)	9,6	9,6
Displacement, cm <sup>3</sup> /cu.in	603/36,8	603/36,8
Fuel, minimum octane grade lead-free	87	87
Tank volume, litres/USqt	12/13	12/13
Oil	Class SF, SG, SH or SJ SAE40, SAE30, SAE10W-30, SAE10W-40 or SAE5W-20	Class SF, SG, SH or SJ SAE40, SAE30, SAE10W-30, SAE10W-40 or SAE5W-20
Oil volume incl. filter	1,7/1,8	1,7/1,8
Oil volume excl. filter, litres/USqt	1,5/1,6	1,5/1,6
Starting	Electric start 12V	Electric start 12V
Max.motor speed, r/min	2900 ± 100	2900 ± 100
<b>Electrical system</b>		
Type	12 V, negative earthed	12 V, negative earthed
Battery	12 V, 24 Ah	12 V, 24 Ah
Spark plug	NGK BPR4ES	NGK BPR4ES
Electrode gap, mm/inch	0,75/0,030	0,75/0,030
Lights	Osram, 2X12V 20W	Osram, 2X12V 20W
<b>Noise emissions and cutting width</b>		
(see note 2)		
Sound power level, measured dB (A)	97	97
Sound power level, guaranteed dB(A)	98	98
Cutting width, cm/inch	94-103-112/37-41-44	94-103-112/37-41-44
<b>Sound levels</b>		
(see note 3)		
Sound pressure level at the operators ear, dB(A)	86	86
<b>Vibration levels</b>		
(see note 4)		
Vibration level on the steering wheel, m/s <sup>2</sup>	2,5	2,5
Vibration level in the seat, m/s <sup>2</sup>	0,7	0,7
<b>Transmission</b>		
Brand	Tuff Torq K46	K 574 KTM 10L
Oil, class SF-CC	SAE 10W/40	SAE 10W/50 Synthetic
<b>Cutting unit</b>		
Type	Combi 94 Combi 103 Combi 112	Combi 94 Combi 103 Combi 112

Note 1: The power rating of the engine indicated is the average net output (at specified rpm) of a typical production engine for the engine model measured to SAE standard J1349/ISO1585. Mass production engines may differ from this value. Actual power output for the engine installed on the final machine will depend on the operating speed, environmental conditions and other values.

Note 2: Noise emissions in the environment measured as sound power (L<sub>WA</sub>) in conformity with EC directive 2000/14/EC.

Note 3: Noise pressure level according to EN 836. Reported data for noise pressure level has a typical statistical dispersion (standard deviation) of 1.2 dB(A).

Note 4: Vibration level according to EN 836. Reported data for vibration level has a typical statistical dispersion (standard deviation) of 0.2 m/s<sup>2</sup> (steering wheel) and 0.8 m/s<sup>2</sup> (seat).

# Technical data

## Dimensions

	Rider 316Ts AWD	Rider 316TXs AWD
Length without cutting unit, mm/ft	2020/6,61	2020/6,61
Width without cutting unit, mm/ft	890/2,92	890/2,92
Height, mm/ft	1150/3,77	1150/3,77
Operating weight with cutting deck, kg/lb	307-312-315/679-688-694	294-299-302/648-659-666
Wheel base, mm/ft	887/2,91	887/2,91
Track width, front, mm/ft	712/2,34	712/2,34
Track width, rear, mm/ft	627/2,06	627/2,06
Tyre dimensions	16 x 6,50 x 8	16 x 6,50 x 8
Air pressure, rear - front, kPa / bar / PSI	60 (0,6/8,5)	60 (0,6/8,5)

## Engine

	Kawasaki / FS481V	Kawasaki / FS481V
Brand / Model	Kawasaki / FS481V	Kawasaki / FS481V
Nominal engine output, kW (see note 1)	9,6	9,6
Displacement, cm <sup>3</sup> /cu.in	603/36,8	603/36,8
Fuel, minimum octane grade lead-free	87	87
Tank volume, litres/USqt	12/13	12/13
Oil	Class SF, SG, SH or SJ SAE40, SAE30, SAE10W-30, SAE10W-40 or SAE5W-20	Class SF, SG, SH or SJ SAE40, SAE30, SAE10W-30, SAE10W-40 or SAE5W-20
Oil volume incl. filter	1,7/1,8	1,7/1,8
Oil volume excl. filter, litres/USqt	1,5/1,6	1,5/1,6
Starting	Electric start 12V	Electric start 12V
Max.motor speed, r/min	2900 ± 100	3100 ± 100

## Electrical system

Type	12 V, negative earthed	12 V, negative earthed
Battery	12 V, 24 Ah	12 V, 24 Ah
Spark plug	NGK BPR4ES	NGK BPR4ES
Electrode gap, mm/inch	0,75/0,030	0,75/0,030
Lights	Osram, 2X12V 20W	Osram, 2X12V 20W

## Noise emissions and cutting width

(see note 2)

Sound power level, measured dB (A)	97	98
Sound power level, guaranteed dB(A)	98	99
Cutting width, cm/inch	94-103-112/37-41-44	94-103-112/37-41-44

## Sound levels

(see note 3)

Sound pressure level at the operators ear, dB(A)	86	83
--	----	----

## Vibration levels

(see note 4)

Vibration level on the steering wheel, m/s <sup>2</sup>	2,5	2,5
Vibration level in the seat, m/s <sup>2</sup>	0,7	0,7

## Transmission

Brand	K 574 KTM 10L	K 574 KTM 10L
Oil, class SF-CC	SAE 10W/50 Synthetic	SAE 10W/50 Synthetic

## Cutting unit

Type	Combi 94	Combi 94
	Combi 103	Combi 103
	Combi 112	Combi 112

Note 1: The power rating of the engine indicated is the average net output (at specified rpm) of a typical production engine for the engine model measured to SAE standard J1349/ISO1585. Mass production engines may differ from this value. Actual power output for the engine installed on the final machine will depend on the operating speed, environmental conditions and other values.

Note 2: Noise emissions in the environment measured as sound power ( $L_{WA}$ ) in conformity with EC directive 2000/14/EC.

Note 3: Noise pressure level according to EN 836. Reported data for noise pressure level has a typical statistical dispersion (standard deviation) of 1.2 dB(A).

Note 4: Vibration level according to EN 836. Reported data for vibration level has a typical statistical dispersion (standard deviation) of 0.2 m/s<sup>2</sup> (steering wheel) and 0.8 m/s<sup>2</sup> (seat).

---

## Technical data

---

Cutting unit	Combi 94	Combi 103	Combi 112
Cutting width, mm/inch	940/37	1030 / 41	1120 / 44.1
Cutting heights, 10 positions, mm/inch	25-75/0.98-2.95	25-75/0.98-2.95	25-75/0.98-2.95
Blade length, mm/inch	358/14.09	388/15.28	420 / 16,5

**IMPORTANT INFORMATION** When the service life of this product has been served and it is no longer used it should be returned to the dealer or to an applicable station for recycling.

**IMPORTANT INFORMATION** We reserve the right to change specifications and designs without prior notice so as to implement improvements.

Note that no legal claims are valid on the basis of information in this manual.

Use only genuine parts for repairs. The warranty is not valid if non genuine parts are used.

### EC-declaration of conformity (Applies to Europe only)

Husqvarna AB, SE-561 82 Huskvarna, Sweden, tel.: +46-36-146500, hereby declares that Husqvarna Rider 316T, Rider 316T AWD, Rider 316TXs AWD and Rider 316Ts AWD from 2012's serial numbers and onwards (the year is clearly stated in plain text on the rating plate with subsequent serial number), complies with the requirements of the COUNCIL'S DIRECTIVE:

of May 17, 2006 "relating to machinery" **2006/42/EC**

of December 15, 2004 "relating to electromagnetic compatibility" **2004/108/EC**.

of May 8, 2000 "relating to the noise emissions in the environment" **2000/14/EC**.

Information regarding noise emissions and the mowing width, see Technical data

The following harmonised standards have been applied: **EN ISO 12100-2, EN-836**.

Notified body: **0404, SMP Svensk Maskinprovning AB**, Fyrisborgsgatan 3, SE-754 50 Uppsala, has issued reports regarding the assessment of conformity according to annex VI of the COUNCIL'S DIRECTIVE of May 8, 2000 "relating to the noise emissions in the environment" 2000/14/EC.

The certificates have the numbers: **01/901/147, 01/901/156**

Huskvarna, 21 December 2011



Claes Losdahl, Development Manager/Garden Products (Authorized representative for Husqvarna AB and responsible for technical documentation.)

**Original instructions  
1154549-26**



**2011-12-22**