

INSTRUCTION MANUAL

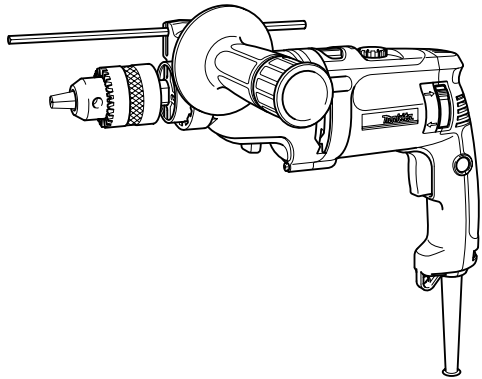

# 2-Speed Hammer Drill

HP2070  
HP2070F  
HP2071  
HP2071F



004284



**IMPORTANT:** Read Before Using.

## ENGLISH (Original instructions)

# SPECIFICATIONS

Model		HP2070/HP2070F		HP2071/HP2071F	
Speed		High	Low	High	Low
Capacities	Concrete	20 mm	-----	20 mm	-----
	Steel	8 mm	16 mm	8 mm	16 mm
	Wood	25 mm	40 mm	25 mm	40 mm
No load speed (min <sup>-1</sup> )		0 - 2,900	0 - 1,200	0 - 2,900	0 - 1,200
Blows per minute		0 - 58,000	0 - 24,000	0 - 58,000	0 - 24,000
Overall length		364 mm		362 mm	
Net weight		2.6 kg		2.6 kg	
Safety class		II/III			

- Due to our continuing programme of research and development, the specifications herein are subject to change without notice.
- Specifications may differ from country to country.
- Weight according to EPTA-Procedure 01/2003

END201-5

ENG905-1

## Symbols

The following show the symbols used for the equipment. Be sure that you understand their meaning before use.



- Read instruction manual.



- DOUBLE INSULATION



- Only for EU countries  
Do not dispose of electric equipment together with household waste material! In observance of European Directive 2002/96/EC on waste electric and electronic equipment and its implementation in accordance with national law, electric equipment that have reached the end of their life must be collected separately and returned to an environmentally compatible recycling facility.

ENE042-1

## Intended use

The tool is intended for hammer drilling and drilling in brick, concrete and stone.

It is also suitable for drilling without impact in wood, metal, ceramic and plastic.

ENF002-2

## Power supply

The tool should be connected only to a power supply of the same voltage as indicated on the nameplate, and can only be operated on single-phase AC supply. They are double-insulated and can, therefore, also be used from sockets without earth wire.

## Noise

The typical A-weighted noise level determined according to EN60745:

- Sound pressure level ( $L_{pA}$ ) : 99 dB(A)
- Sound power level ( $L_{WA}$ ) : 110 dB(A)
- Uncertainty (K) : 3 dB(A)

## Wear ear protection

ENG900-1

## Vibration

The vibration total value (tri-axial vector sum) determined according to EN60745:

- Work mode: impact drilling into concrete  
Vibration emission ( $a_{h,1D}$ ) : 16.0 m/s<sup>2</sup>  
Uncertainty (K) : 1.5 m/s<sup>2</sup>

- Work mode: drilling into metal  
Vibration emission ( $a_{h,D}$ ) : 2.5 m/s<sup>2</sup>  
Uncertainty (K) : 1.5 m/s<sup>2</sup>

ENG901-1

- The declared vibration emission value has been measured in accordance with the standard test method and may be used for comparing one tool with another.
- The declared vibration emission value may also be used in a preliminary assessment of exposure.

## ⚠WARNING:

- The vibration emission during actual use of the power tool can differ from the declared emission value depending on the ways in which the tool is used.
- Be sure to identify safety measures to protect the operator that are based on an estimation of exposure in the actual conditions of use (taking

account of all parts of the operating cycle such as the times when the tool is switched off and when it is running idle in addition to the trigger time).

ENH101-15

#### For European countries only

#### EC Declaration of Conformity

We Makita Corporation as the responsible manufacturer declare that the following Makita machine(s):

Designation of Machine:

2-Speed Hammer Drill

Model No./ Type: HP2070,HP2070F,HP2071,HP2071F

are of series production and

Conforms to the following European Directives:

2006/42/EC

And are manufactured in accordance with the following standards or standardised documents:

EN60745

The technical documentation is kept by our authorised representative in Europe who is:

Makita International Europe Ltd.

Michigan Drive, Tongwell,

Milton Keynes, Bucks MK15 8JD, England

30.1.2009



000230

Tomoyasu Kato

Director

Makita Corporation

3-11-8, Sumiyoshi-cho,

Anjo, Aichi, 446-8502, JAPAN

GEA005-3

## General Power Tool Safety

### Warnings

**⚠ WARNING** Read all safety warnings and all instructions. Failure to follow the warnings and instructions may result in electric shock, fire and/or serious injury.

### Save all warnings and instructions for future reference.

The term "power tool" in the warnings refers to your mains-operated (corded) power tool or battery-operated (cordless) power tool.

#### Work area safety

1. **Keep work area clean and well lit.** Cluttered or dark areas invite accidents.

2. **Do not operate power tools in explosive atmospheres, such as in the presence of flammable liquids, gases or dust.** Power tools create sparks which may ignite the dust or fumes.
3. **Keep children and bystanders away while operating a power tool.** Distractions can cause you to lose control.

#### Electrical safety

4. **Power tool plugs must match the outlet. Never modify the plug in any way. Do not use any adapter plugs with earthed (grounded) power tools.** Unmodified plugs and matching outlets will reduce risk of electric shock.
5. **Avoid body contact with earthed or grounded surfaces such as pipes, radiators, ranges and refrigerators.** There is an increased risk of electric shock if your body is earthed or grounded.
6. **Do not expose power tools to rain or wet conditions.** Water entering a power tool will increase the risk of electric shock.
7. **Do not abuse the cord. Never use the cord for carrying, pulling or unplugging the power tool. Keep cord away from heat, oil, sharp edges or moving parts.** Damaged or entangled cords increase the risk of electric shock.
8. **When operating a power tool outdoors, use an extension cord suitable for outdoor use.** Use of a cord suitable for outdoor use reduces the risk of electric shock.
9. **If operating a power tool in a damp location is unavoidable, use a residual current device (RCD) protected supply.** Use of an RCD reduces the risk of electric shock.
10. **Use of power supply via a RCD with a rated residual current of 30mA or less is always recommended.**

#### Personal safety

11. **Stay alert, watch what you are doing and use common sense when operating a power tool. Do not use a power tool while you are tired or under the influence of drugs, alcohol or medication.** A moment of inattention while operating power tools may result in serious personal injury.
12. **Use personal protective equipment. Always wear eye protection.** Protective equipment such as dust mask, non-skid safety shoes, hard hat, or hearing protection used for appropriate conditions will reduce personal injuries.
13. **Prevent unintentional starting. Ensure the switch is in the off-position before connecting to power source and/or battery pack, picking up or carrying the tool.** Carrying power tools with your finger on the switch or energising power tools that have the switch on invites accidents.

14. **Remove any adjusting key or wrench before turning the power tool on.** A wrench or a key left attached to a rotating part of the power tool may result in personal injury.
15. **Do not overreach. Keep proper footing and balance at all times.** This enables better control of the power tool in unexpected situations.
16. **Dress properly. Do not wear loose clothing or jewellery. Keep your hair, clothing, and gloves away from moving parts.** Loose clothes, jewellery or long hair can be caught in moving parts.
17. **If devices are provided for the connection of dust extraction and collection facilities, ensure these are connected and properly used.** Use of dust collection can reduce dust-related hazards.

#### **Power tool use and care**

18. **Do not force the power tool. Use the correct power tool for your application.** The correct power tool will do the job better and safer at the rate for which it was designed.
19. **Do not use the power tool if the switch does not turn it on and off.** Any power tool that cannot be controlled with the switch is dangerous and must be repaired.
20. **Disconnect the plug from the power source and/or the battery pack from the power tool before making any adjustments, changing accessories, or storing power tools.** Such preventive safety measures reduce the risk of starting the power tool accidentally.
21. **Store idle power tools out of the reach of children and do not allow persons unfamiliar with the power tool or these instructions to operate the power tool.** Power tools are dangerous in the hands of untrained users.
22. **Maintain power tools. Check for misalignment or binding of moving parts, breakage of parts and any other condition that may affect the power tool's operation. If damaged, have the power tool repaired before use.** Many accidents are caused by poorly maintained power tools.
23. **Keep cutting tools sharp and clean.** Properly maintained cutting tools with sharp cutting edges are less likely to bind and are easier to control.
24. **Use the power tool, accessories and tool bits etc. in accordance with these instructions, taking into account the working conditions and the work to be performed.** Use of the power tool for operations different from those intended could result in a hazardous situation.

#### **Service**

25. **Have your power tool serviced by a qualified repair person using only identical replacement parts.** This will ensure that the safety of the power tool is maintained.
26. **Follow instruction for lubricating and changing accessories.**
27. **Keep handles dry, clean and free from oil and grease.**

GEB003-5

## **HAMMER DRILL SAFETY WARNINGS**

1. **Wear ear protectors when impact drilling.** Exposure to noise can cause hearing loss.
2. **Use auxiliary handle(s), if supplied with the tool.** Loss of control can cause personal injury.
3. **Hold power tool by insulated gripping surfaces, when performing an operation where the cutting accessory may contact hidden wiring or its own cord.** Cutting accessory contacting a "live" wire may make exposed metal parts of the power tool "live" and could give the operator an electric shock.
4. **Always be sure you have a firm footing.** Be sure no one is below when using the tool in high locations.
5. **Hold the tool firmly with both hands.**
6. **Keep hands away from rotating parts.**
7. **Do not leave the tool running. Operate the tool only when hand-held.**
8. **Do not touch the bit or the workpiece immediately after operation; they may be extremely hot and could burn your skin.**
9. **Some material contains chemicals which may be toxic. Take caution to prevent dust inhalation and skin contact. Follow material supplier safety data.**

## **SAVE THESE INSTRUCTIONS.**

### **⚠WARNING:**

**DO NOT** let comfort or familiarity with product (gained from repeated use) replace strict adherence to safety rules for the subject product. **MISUSE** or failure to follow the safety rules stated in this instruction manual may cause serious personal injury.

# FUNCTIONAL DESCRIPTION

**⚠ CAUTION:**

- Always be sure that the tool is switched off and unplugged before adjusting or checking function on the tool.

**Switch action**

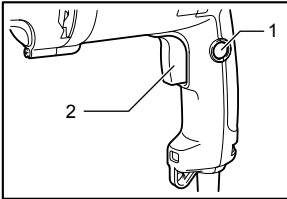

1. Lock button
2. Switch trigger

004285

**⚠ CAUTION:**

- Before plugging in the tool, always check to see that the switch trigger actuates properly and returns to the "OFF" position when released.

To start the tool, simply pull the switch trigger. Tool speed is increased by increasing pressure on the switch trigger. Release the switch trigger to stop.

For continuous operation, pull the switch trigger and then push in the lock button.

To stop the tool from the locked position, pull the switch trigger fully, then release it.

A speed adjusting dial is provided so that maximum tool speed can be limited (variable). Turn the speed adjusting dial clockwise for higher speed, and counterclockwise for lower speed.

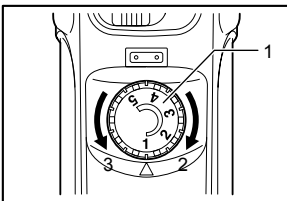

1. Speed adjusting dial
2. Higher
3. Lower

004286

**Lighting up the lamps**

For Model HP2070F, HP2071F

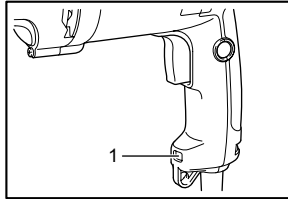

1. Lamp

004287

**⚠ CAUTION:**

- Do not look in the light or see the source of light directly.

To turn on the lamp, pull the trigger. Release the trigger to turn it off.

**NOTE:**

- Use a dry cloth to wipe the dirt off the lens of lamp. Be careful not to scratch the lens of lamp, or it may lower the illumination.
- Never use gasoline or thinner to clean the lens of the lamp, or it will be damaged.

**Reversing switch action**

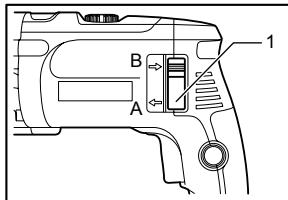

1. Reversing switch

004288

This tool has a reversing switch to change the direction of rotation. Move the reversing switch lever to the ⇐ position (A side) for clockwise rotation or the ⇒ position (B side) for counterclockwise rotation.

**⚠ CAUTION:**

- Always check the direction of rotation before operation.
- Use the reversing switch only after the tool comes to a complete stop. Changing the direction of rotation before the tool stops may damage the tool.
- If the switch trigger can not be depressed, check to see that the reversing switch is fully set to position ⇐ (A side) or ⇒ (B side).

## Speed change

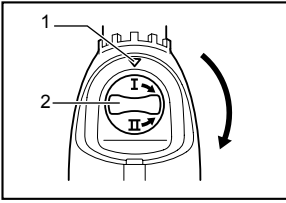

1. Arrow
2. Speed change knob

002691

Two speed ranges can be preselected with the speed change knob.

To change the speed, turn the speed change knob so that the arrow on the tool body points toward the "I" position on the knob for low speed or "II" position for high speed. If it is hard to turn the knob, first turn the chuck slightly in either direction and then turn the knob again.

### ⚠ CAUTION:

- Use the speed change knob only after the tool comes to a complete stop. Changing the tool speed before the tool stops may damage the tool.
- Always set the speed change knob to the correct position. If you operate the tool with the speed change knob positioned halfway between the "I" and "II" position, the tool may be damaged.

## Selecting the action mode

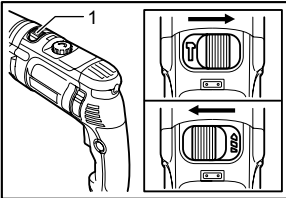

1. Action mode changing lever

004289

This tool has an action mode change lever. For rotation with hammering, slide the action mode change lever to the right (T symbol). For rotation only, slide the action mode change lever to the left (R symbol).

### ⚠ CAUTION:

- Always slide the action mode change lever all the way to your desired mode position. If you operate the tool with the lever positioned halfway between the mode symbols, the tool may be damaged.

## ASSEMBLY

### ⚠ CAUTION:

- Always be sure that the tool is switched off and unplugged before carrying out any work on the tool.

### Installing side grip (auxiliary handle)

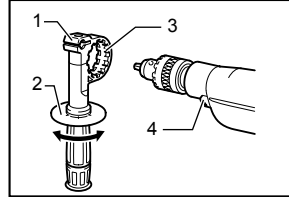

1. Grip base
2. Side grip (auxiliary handle)
3. Teeth
4. Protrusions

002693

Always use the side grip to ensure operating safety. Install the side grip so that the teeth on the grip fit in between the protrusions on the tool barrel.

Then tighten the grip by turning clockwise at the desired position. It may be swung 360° so as to be secured at any position.

### Installing or removing drill bit For Model HP2070, HP2070F

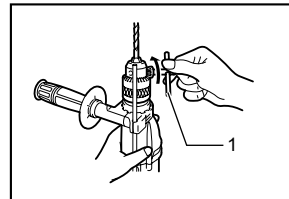

1. Chuck key

002694

To install the bit, place it in the chuck as far as it will go. Tighten the chuck by hand. Place the chuck key in each of the three holes and tighten clockwise. Be sure to tighten all three chuck holes evenly.

To remove the bit, turn the chuck key counterclockwise in just one hole, then loosen the chuck by hand.

After using the chuck key, be sure to return to the original position.

### For Model HP2071, HP2071F

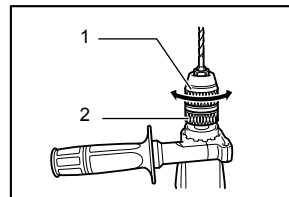

1. Sleeve
2. Ring

002695

Hold the ring and turn the sleeve counterclockwise to open the chuck jaws. Place the bit in the chuck as far as it will go. Hold the ring firmly and turn the sleeve clockwise to tighten the chuck.

To remove the bit, hold the ring and turn the sleeve counterclockwise.

**NOTE:**

- If the keyless drill chuck cannot be loosened because of a drill bit being caught inside the jaws of the chuck, loosen the drill chuck as follows.

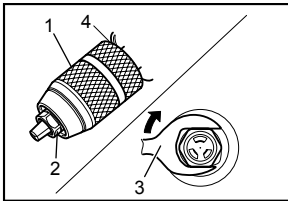

1. Sleeve
2. Hexagonal nut
3. Wrench 19
4. Retaining ring

004390

1. Hold the sleeve of the drill chuck firmly with water pump pliers or the like (Note: Do not hold the retaining ring portion.)
2. Place the wrench 19, adjustable wrench or one of other appropriate wrenches on the hexagonal nut at the front of the drill chuck. Turn the wrench clockwise as shown in the figure to loosen the drill chuck.

**Depth gauge**

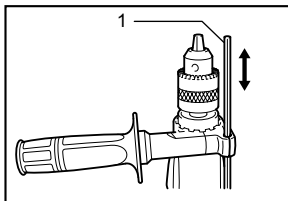

1. Depth gauge

002696

The depth gauge is convenient for drilling holes of uniform depth. Loosen the side grip and insert the depth gauge into the hole in the side grip. Adjust the depth gauge to the desired depth and tighten the side grip.

**NOTE:**

- The depth gauge cannot be used at the position where the depth gauge strikes against the tool body.

**OPERATION**

**Hammer drilling operation**

**⚠CAUTION:**

- There is a tremendous and sudden twisting force exerted on the tool/bit at the time of hole break-through, when the hole becomes clogged with chips and particles, or when striking reinforcing rods embedded in the concrete. Always use the side grip (auxiliary handle) and firmly hold the tool by both side grip and switch handle during operations. Failure to do so may result in the loss of control of the tool and potentially severe injury.

When drilling in concrete, granite, tile, etc., move the action mode changing lever to the position of  $\bar{T}$  symbol to use "rotation with hammering" action.

Be sure to use a tungsten-carbide tipped bit.

Position the bit at the desired location for the hole, then pull the switch trigger. Do not force the tool. Light pressure gives best results. Keep the tool in position and prevent it from slipping away from the hole.

Do not apply more pressure when the hole becomes clogged with chips or particles. Instead, run the tool at an idle, then remove the bit partially from the hole. By repeating this several times, the hole will be cleaned out and normal drilling may be resumed.

**Blow-out bulb (optional accessory)**

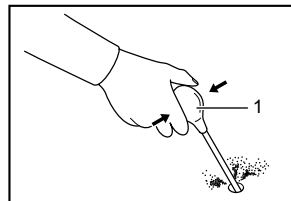

1. Blow-out bulb

001302

After drilling the hole, use the blow-out bulb to clean the dust out of the hole.

**Drilling operation**

When drilling in wood, metal or plastic materials, move the action mode changing lever to the position of  $\bar{R}$  symbol to use "rotation only" action.

**Drilling in wood**

When drilling in wood, the best results are obtained with wood drills equipped with a guide screw. The guide screw makes drilling easier by pulling the bit into the workpiece.

**Drilling in metal**

To prevent the bit from slipping when starting a hole, make an indentation with a center-punch and hammer at the point to be drilled. Place the point of the bit in the indentation and start drilling.

Use a cutting lubricant when drilling metals. The

exceptions are iron and brass which should be drilled dry.

**⚠ CAUTION:**

- Pressing excessively on the tool will not speed up the drilling. In fact, this excessive pressure will only serve to damage the tip of your bit, decrease the tool performance and shorten the service life of the tool.
- There is a tremendous force exerted on the tool/bit at the time of hole break through. Hold the tool firmly and exert care when the bit begins to break through the workpiece.
- A stuck bit can be removed simply by setting the reversing switch to reverse rotation in order to back out. However, the tool may back out abruptly if you do not hold it firmly.
- Always secure small workpieces in a vise or similar hold-down device.

## MAINTENANCE

**⚠ CAUTION:**

- Always be sure that the tool is switched off and unplugged before attempting to perform inspection or maintenance.
- Never use gasoline, benzine, thinner, alcohol or the like. Discoloration, deformation or cracks may result.

### Indicator lamp

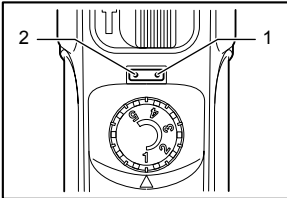

004290

1. Power-ON indicator lamp (green)
2. Service indicator lamp (red)

The green power-ON indicator lamp lights up when the tool is switched ON. If the indicator lamp is lit but the tool does not start, the carbon brushes may be worn out, or the electric circuit or the motor may be defective. If the indicator lamp does not light up and the tool does not start, the ON/OFF switch or the mains cord may be defective. The red service indicator lamp lights up when the tool is excessively loaded. Continued operation under such a condition will result in a failure or breakage of the tool. At this time, cool down the tool by running the tool under no load.

### Cleaning vent holes

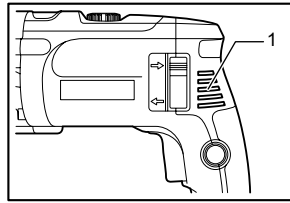

004291

1. Vent holes

The tool and its air vents have to be kept clean. Regularly clean the tool's air vents or whenever the vents start to become obstructed.

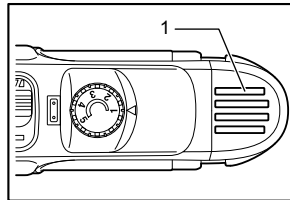

004350

1. Vent holes

To maintain product SAFETY and RELIABILITY, repairs, carbon brush inspection and replacement, any other maintenance or adjustment should be performed by Makita Authorized Service Centers, always using Makita replacement parts.

## OPTIONAL ACCESSORIES

**⚠ CAUTION:**

- These accessories or attachments are recommended for use with your Makita tool specified in this manual. The use of any other accessories or attachments might present a risk of injury to persons. Only use accessory or attachment for its stated purpose.

If you need any assistance for more details regarding these accessories, ask your local Makita Service Center.

- Tungsten-carbide tipped hammer bit
- Hole saws
- Blow-out bulb
- Safety goggles
- Keyless drill chuck 13
- Chuck key
- Grip assembly
- Depth gauge
- Plastic carrying case

**NOTE:**

- Some items in the list may be included in the tool package as standard accessories. They may differ from country to country.









**Makita Corporation**  
Anjo, Aichi, Japan

884501F220

[www.makita.com](http://www.makita.com)