

INSTRUCTION MANUAL

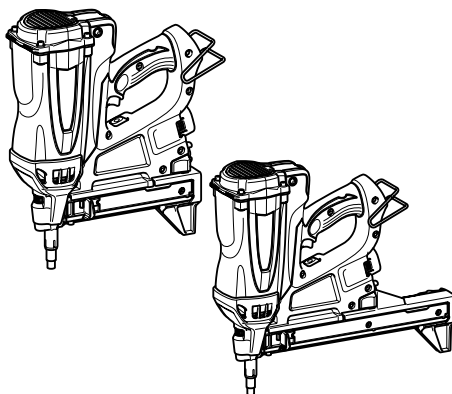

Cordless Concrete Nailer

GN420C



013225

IMPORTANT: Read Before Using.

ENGLISH (Original instructions)

SPECIFICATIONS

Model	GN420C	
Nail capacity	20 nails (2strips)	40 nails (4strips)
Dimensions (L X W X H)	315 mm X 108 mm X 390 mm	430 mm X 108 mm X 390 mm
Net weight	3.6 kg	3.8 kg
Nail length X Shank diameter	Nail L : 15 mm - 40 mm	d : 2.6 mm - 3.1 mm
Rated voltage	D.C. 7.2 V	

- Due to our continuing program of research and development, the specifications herein are subject to change without notice.
- Specifications and battery cartridge may differ from country to country.
- Weight, with battery cartridge, according to EPTA-Procedure 01/2003

END107-5

Symbols

The following show the symbols used for the equipment. Be sure that you understand their meaning before use.



- Read instruction manual.



- Container under pressure, keep away from temperatures over 50°C (for ex. sun radiation) Keep container in a well ventilated place.



- Use only outside or well ventilated rooms. Do not breathe gas.



- Do not use near flames or sprays on heated surfaces. In use, may form flammable/explosive vapour-air mixture.



- Do not damage, puncture or burn even after use.



- Wear safety glasses.



- Keep fingers away from trigger when not driving fasteners to avoid accidental firing.



- Use only in ventilated area to avoid nausea and unconsciousness. Never use tool in combustible atmospheres. The tool exhaust may ignite flammable materials.



- Do not use on scaffolding, ladders.



- Warning: hot surface!
Do not touch around this symbol. Touching the surface may cause burns or injuries.



- Only for EU countries
Do not dispose of electric equipment or battery pack together with household waste material!

In observance of European Directive 2002/96/EC on waste electric and electronic equipment, 2006/66/EC on

batteries and accumulators and waste batteries and accumulators and their implementation in accordance with national laws, electric equipment and battery pack that have reached the end of their life must be collected separately and returned to an environmentally compatible recycling facility.

ENE072-1

Intended use

The tool is intended for securing a thin steel plate to the concrete.

ENG905-1

Noise

The typical A-weighted noise level determined according to EN792:

Sound pressure level (L_{pA}) : 89 dB(A)

Sound power level (L_{WA}) : 102 dB(A)

Uncertainty (K) : 3 dB(A)

Wear ear protection

ENG904-2

Vibration

The vibration total value determined according to EN792:

Vibration emission (a_{h1}) : 3.5 m/s²

Uncertainty (K) : 1.5 m/s²

ENG901-1

- The declared vibration emission value has been measured in accordance with the standard test method and may be used for comparing one tool with another.
- The declared vibration emission value may also be used in a preliminary assessment of exposure.

WARNING:

- The vibration emission during actual use of the power tool can differ from the declared emission value depending on the ways in which the tool is used.

- Be sure to identify safety measures to protect the operator that are based on an estimation of exposure in the actual conditions of use (taking account of all parts of the operating cycle such as the times when the tool is switched off and when it is running idle in addition to the trigger time).

ENH003-14

For European countries only

EC Declaration of Conformity

We Makita Corporation as the responsible manufacturer declare that the following Makita machine(s):

Designation of Machine:
Cordless Concrete Nailer
Model No./ Type: GN420C
are of series production and

Conforms to the following European Directives:
2006/42/EC

And are manufactured in accordance with the following standards or standardised documents:

EN792, EN60745

The technical documentation is kept by:

Makita International Europe Ltd.
Technical Department,
Michigan Drive, Tongwell,
Milton Keynes, Bucks MK15 8JD, England

29.03.2012



000230

Tomoyasu Kato
Director

Makita Corporation
3-11-8, Sumiyoshi-cho,
Anjo, Aichi, 446-8502, JAPAN

GEA006-2

General Power Tool Safety

Warnings

⚠ WARNING Read all safety warnings and all instructions. Failure to follow the warnings and instructions may result in electric shock, fire and/or serious injury.

Save all warnings and instructions for future reference.

The term "power tool" in the warnings refers to your mains-operated (corded) power tool or battery-operated (cordless) power tool.

Work area safety

1. **Keep work area clean and well lit.** Cluttered or dark areas invite accidents.
2. **Do not operate power tools in explosive atmospheres, such as in the presence of flammable liquids, gases or dust.** Power tools create sparks which may ignite the dust or fumes.
3. **Keep children and bystanders away while operating a power tool.** Distractions can cause you to lose control.

Electrical safety

4. **Power tool plugs must match the outlet. Never modify the plug in any way. Do not use any adapter plugs with earthed (grounded) power tools.** Unmodified plugs and matching outlets will reduce risk of electric shock.
5. **Avoid body contact with earthed or grounded surfaces such as pipes, radiators, ranges and refrigerators.** There is an increased risk of electric shock if your body is earthed or grounded.
6. **Do not expose power tools to rain or wet conditions.** Water entering a power tool will increase the risk of electric shock.
7. **Do not abuse the cord. Never use the cord for carrying, pulling or unplugging the power tool. Keep cord away from heat, oil, sharp edges or moving parts.** Damaged or entangled cords increase the risk of electric shock.
8. **When operating a power tool outdoors, use an extension cord suitable for outdoor use.** Use of a cord suitable for outdoor use reduces the risk of electric shock.
9. **If operating a power tool in a damp location is unavoidable, use a ground fault circuit interrupter (GFCI) protected supply.** Use of an GFCI reduces the risk of electric shock.

Personal safety

10. **Stay alert, watch what you are doing and use common sense when operating a power tool. Do not use a power tool while you are tired or under the influence of drugs, alcohol or medication.** A moment of inattention while operating power tools may result in serious personal injury.
11. **Use personal protective equipment. Always wear eye protection.** Protective equipment such as dust mask, non-skid safety shoes, hard hat, or hearing protection used for appropriate conditions will reduce personal injuries.
12. **Prevent unintentional starting. Ensure the switch is in the off-position before connecting to power source and/or battery pack, picking up or carrying the tool.** Carrying power tools with your finger on the switch or energising power tools that have the switch on invites accidents.

13. **Remove any adjusting key or wrench before turning the power tool on.** A wrench or a key left attached to a rotating part of the power tool may result in personal injury.
14. **Do not overreach. Keep proper footing and balance at all times.** This enables better control of the power tool in unexpected situations.
15. **Dress properly. Do not wear loose clothing or jewellery. Keep your hair, clothing, and gloves away from moving parts.** Loose clothes, jewellery or long hair can be caught in moving parts.
16. **If devices are provided for the connection of dust extraction and collection facilities, ensure these are connected and properly used.** Use of dust collection can reduce dust-related hazards.

Power tool use and care

17. **Do not force the power tool. Use the correct power tool for your application.** The correct power tool will do the job better and safer at the rate for which it was designed.
18. **Do not use the power tool if the switch does not turn it on and off.** Any power tool that cannot be controlled with the switch is dangerous and must be repaired.
19. **Disconnect the plug from the power source and/or the battery pack from the power tool before making any adjustments, changing accessories, or storing power tools.** Such preventive safety measures reduce the risk of starting the power tool accidentally.
20. **Store idle power tools out of the reach of children and do not allow persons unfamiliar with the power tool or these instructions to operate the power tool.** Power tools are dangerous in the hands of untrained users.
21. **Maintain power tools. Check for misalignment or binding of moving parts, breakage of parts and any other condition that may affect the power tool's operation. If damaged, have the power tool repaired before use.** Many accidents are caused by poorly maintained power tools.
22. **Keep cutting tools sharp and clean.** Properly maintained cutting tools with sharp cutting edges are less likely to bind and are easier to control.
23. **Use the power tool, accessories and tool bits etc. in accordance with these instructions, taking into account the working conditions and the work to be performed.** Use of the power tool for operations different from those intended could result in a hazardous situation.

Battery tool use and care

24. **Recharge only with the charger specified by the manufacturer.** A charger that is suitable for one type of battery pack may create a risk of fire when used with another battery pack.

25. **Use power tools only with specifically designated battery packs.** Use of any other battery packs may create a risk of injury and fire.
26. **When battery pack is not in use, keep it away from other metal objects, like paper clips, coins, keys, nails, screws or other small metal objects, that can make a connection from one terminal to another.** Shorting the battery terminals together may cause burns or a fire.
27. **Under abusive conditions, liquid may be ejected from the battery; avoid contact. If contact accidentally occurs, flush with water. If liquid contacts eyes, additionally seek medical help.** Liquid ejected from the battery may cause irritation or burns.

Service

28. **Have your power tool serviced by a qualified repair person using only identical replacement parts.** This will ensure that the safety of the power tool is maintained.
29. **Follow instruction for lubricating and changing accessories.**
30. **Keep handles dry, clean and free from oil and grease.**

ENB111-4

Cordless nailer/stapler safety warnings

⚠ WARNING Read all safety warnings and all instructions. Failure to follow the warnings and instructions may result in serious injury, electric shock and/or fire.

Save all warnings and instructions for future reference.

For personal safety and proper operation and maintenance of the tool, read this instruction manual before using the tool.

General safety

- Do not permit those uninstructed to use the tool.
- No horseplay. Respect the tool as a working implement.
- Do not operate when under the influence of alcohol, drugs or the like.
- Never alter the tool.

Personal protective equipments

- Always wear safety glasses to protect your eyes from dust or fastener injury.

⚠WARNING: It is an employer's responsibility to enforce the use of safety eye protection equipment by the tool operators and by other persons in the immediate working area.

For Australia and New Zealand only

Always wear safety glasses and face shield to protect your eyes from dust or fastener injury. The safety glasses and the face shield should conform with the requirements of AS/NZS 1336.



000114

- Wear hearing protection to protect your ears against exhaust noise and head protection. Also wear light but not loose clothing. Sleeves should be buttoned or rolled up. No necktie should be worn.

Work area safety

- Never use the tool in enclosed or poorly ventilated spaces. Otherwise carbon monoxide may cause dizziness, nausea or unconsciousness.
- Keep work area clean and well lit. Cluttered or dark areas invite accidents.
- Do not operate the tool in explosive atmospheres, such as in the presence of flammable liquids, gases or dust. Operating the tool can create sparks which may ignite the dust or fumes.
- Keep children and bystanders away while operating the tool. Distractions can cause you to lose control.
- Illuminate the work area sufficiently.
- There may be local regulations concerning noise which must be complied with by keeping noise levels within prescribed limits. In certain cases, shutters should be used to contain noise.

Safety devices

- Make sure all safety systems are in working order before operation. The tool must not operate if only the trigger is pulled or if only the contact arm is pressed against the wood. It must work only when both actions are performed. Test for possible faulty operation with fasteners unloaded and the pusher in fully pulled position.
- Do not play with the contact element: it prevents accidental discharge, so it must be kept on and not removed. Securing the trigger in the ON position is also very dangerous. Never attempt to fasten the trigger. Do not operate a tool if any portion of the tool operating controls is inoperable, disconnected, altered, or not working properly.

- Do not attempt to keep the contact element depressed with tape or wire. Death or serious injury may occur.
- Always check contact element as instructed in this manual. fasteners may be driven accidentally if the safety mechanism is not working correctly.

Loading fasteners

- Do not load the tool with fasteners when any one of the operating controls is activated.
- Use only fasteners specified in this manual. The use of any other fasteners may cause malfunction of the tool.

Power source

- Use the tool only with the Makita genuine fuel cell.
- Do not touch liquid gas sprayed out of the fuel cell. Contact with it may cause injury.
- Risk of fire and explosion. When handling the fuel cell for the purpose of storage, transportation, inserting into and taking out of the tool and disposal:
 - do not expose to sunlight and to temperatures exceeding 50 ° C (122 ° F);
 - do not smoke;
 - avoid sparks and open flame.
- Always remove the battery cartridge and remove all of the fasteners:
 - when unattended;
 - before performing any maintenance or repair;
 - before cleaning a jam;
 - before moving the tool to a new location.

Operational safety

- Always check the tool for its overall condition and loose screws before operation. Tighten as required.
- Handle the tool carefully, as there is high pressure inside the tool that can be dangerous if a crack is caused by rough handling (dropping or striking). Do not attempt to carve or engrave on the tool.
- Stop the operation immediately if you notice something wrong or out of the ordinary with the tool. An improperly functioning tool must not be used.
- Do not point the ejection port at anyone in the vicinity. Keep hands and feet away from the ejection port area.
- Always assume that the tool contains fasteners.
- Never point the tool toward yourself or anyone whether it contains fasteners or not.
- Do not rush the job or force the tool. Handle the tool carefully.
- Do not activate the tool unless the tool is placed firmly against the workpiece.
- Never hold or carry the tool with a finger on the trigger or hand it to someone in this condition. Accidental firing can cause serious injury.
- Never use fastener driving tools marked with the symbol "Do not use on scaffoldings, ladders" for specific application for example:

- when changing one driving location to another involves the use of scaffoldings, stairs, ladders, or ladder alike constructions, e.g. roof laths;
 - closing boxes or crates;
 - fitting transportation safety systems e.g. on vehicles and wagons.
- Check walls, ceilings, floors, roofing and the like carefully to avoid possible electrical shock, gas leakage, explosions, etc. caused by striking live wires, conduits or gas pipes.
 - Do not use the tool for fastening electrical cables. It is not designed for electric cable installation and may damage the insulation of electric cables thereby causing electric shock or fire hazards.
 - Watch your footing and maintain your balance with the tool. Make sure there is no one below when working in high locations to prevent danger if there is sudden jerking or catching.
 - On rooftops and other high locations, drive fasteners as you move forward. It is easy to lose your footing if you drive fasteners while inching backward. When driving fasteners against perpendicular surface, work from the top to the bottom. You can perform driving operations with less fatigue by doing so.
 - A fastener will be bent or the tool can become jammed if you mistakenly drive fastener on top of another fastener or strike a knot in the wood. The fastener may be thrown and hit someone, or the tool itself can react dangerously. Place the fasteners with care.
 - Never attempt to drive fasteners from both the inside and outside at the same time. Fasteners may rip through and/or fly off, presenting a grave danger.

Service

- Perform cleaning and maintenance right after finishing the job. Keep the tool in tip-top condition. Lubricate moving parts to prevent rusting and minimize friction-related wear. Wipe off all dust from the parts.
- Ask Makita authorized service center for periodical inspection of the tool.
- To maintain product SAFETY and RELIABILITY, maintenance and repairs should be performed by Makita Authorized Service Centers, always using Makita replacement parts.

SAVE THESE INSTRUCTIONS.

WARNING:

DO NOT let comfort or familiarity with product (gained from repeated use) replace strict adherence to safety rules for the subject product. MISUSE or failure to follow the safety rules stated in this

instruction manual may cause serious personal injury.

ENC009-1

IMPORTANT SAFETY INSTRUCTIONS

FOR BATTERY CARTRIDGE

1. **Before using battery cartridge, read all instructions and cautionary markings on (1) battery charger, (2) battery, and (3) product using battery.**
2. **Do not disassemble battery cartridge.**
3. **If operating time has become excessively shorter, stop operating immediately. It may result in a risk of overheating, possible burns and even an explosion.**
4. **If electrolyte gets into your eyes, rinse them out with clear water and seek medical attention right away. It may result in loss of your eyesight.**
5. **Do not short the battery cartridge:**
 - (1) **Do not touch the terminals with any conductive material.**
 - (2) **Avoid storing battery cartridge in a container with other metal objects such as nails, coins, etc.**
 - (3) **Do not expose battery cartridge to water or rain.**

A battery short can cause a large current flow, overheating, possible burns and even a breakdown.

6. **Do not store the tool and battery cartridge in locations where the temperature may reach or exceed 50 ° C (122 ° F).**
7. **Do not incinerate the battery cartridge even if it is severely damaged or is completely worn out. The battery cartridge can explode in a fire.**
8. **Be careful not to drop or strike battery.**
9. **Do not use a damaged battery.**

SAVE THESE INSTRUCTIONS.

Tips for maintaining maximum battery life

1. **Charge the battery cartridge before completely discharged. Always stop tool operation and charge the battery cartridge when you notice less tool power.**
2. **Never recharge a fully charged battery cartridge. Overcharging shortens the battery service life.**
3. **Charge the battery cartridge with room temperature at 10 ° C - 40 ° C (50 ° F - 104 ° F). Let a hot battery cartridge cool down before charging it.**

Overview of the nailer

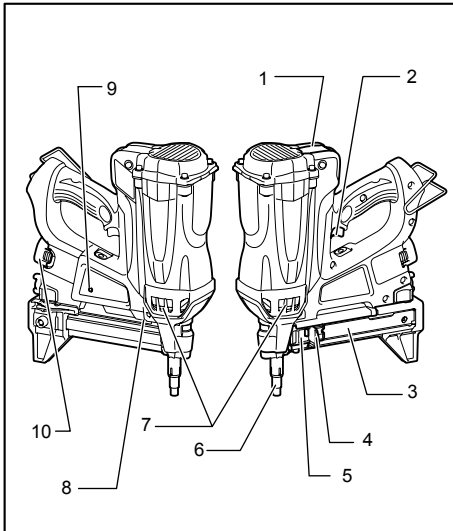

1. Fuel cover
2. Trigger
3. Magazine
4. Pusher lever
5. Pusher button
6. Contact element
7. Exhaust vent
8. Lamp
9. Indicating lamp
10. Battery cartridge

013150

FUNCTIONAL DESCRIPTION

⚠ CAUTION:

- Always be sure to remove the fuel cell, the battery cartridge and nails before adjusting or checking function on the tool.

Installing or removing battery cartridge

⚠ CAUTION:

- Always switch off the tool before installing or removing of the battery cartridge.
- **Hold the tool and the battery cartridge firmly when installing or removing battery cartridge.** Failure to hold the tool and the battery cartridge firmly may cause them to slip off your hands and result in damage to the tool and battery cartridge and a personal injury.

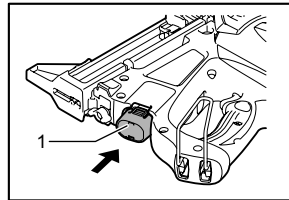

1. Battery cartridge

013181

To install the battery cartridge, hold it so that the battery cartridge front shape fits to that of the battery installation opening and slip it into place. Insert it all the way until it locks in place with a little click.

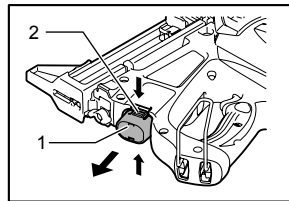

1. Battery cartridge
2. Button

013151

To remove the battery cartridge, withdraw it from the tool while pressing the both sides of the cartridge.

⚠ CAUTION:

- Always insert the battery cartridge all the way until it locks in place. If not, it may accidentally fall out of the tool, causing injury to you or someone around you.
- Do not install the battery cartridge forcibly. If the cartridge does not slide in easily, it is not being inserted correctly.

Lighting up the lamp

⚠ CAUTION:

- Do not look in the light or see the source of light directly.

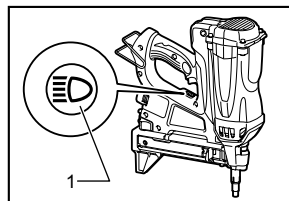

1. Lamp button

013167

- To switch on the Lamp, press the lamp button. To switch off the lamp, press the lamp button again.

Fuel cell

Attaching the metering valve to the fuel cell

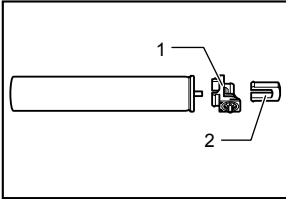

1. Metering valve
2. Cap

009445

Detach the cap (in case the metering valve is provided with the cap).

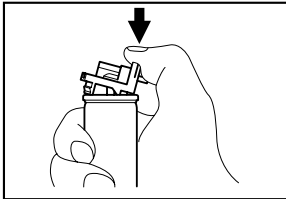

009446

Push in the front edge.

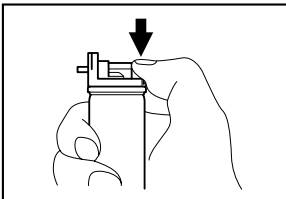

009447

Push in the rear edge until it seats.

Inserting the fuel cell

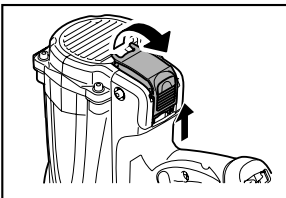

013152

Push up and pull the fuel cover to open.

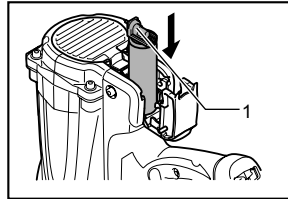

1. Jet nozzle

013153

Insert the fuel cell directing the jet nozzle of the metering valve toward the adaptor.

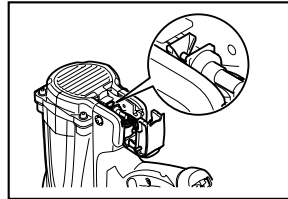

013154

Insert the jet nozzle into the small hole of the adaptor properly.

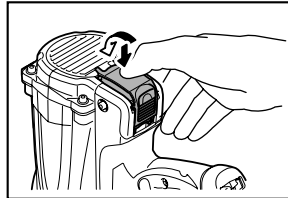

013155

Put the fuel cover over the metering valve and push it down to latch.

Adjusting the nailing depth

⚠CAUTION:

- Remove the fuel cell, the battery cartridge and nails before adjusting the depth of nailing.

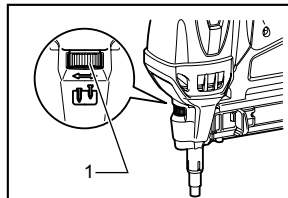

1. Adjuster

013168

To get shallower depth, turn the adjuster to right direction as shown in the figure. To get deeper depth, turn the adjuster to left direction.

Do not turn the adjuster too much, or the adjuster may get stuck.

Indication lamp

Color of the indication lamp means the followings.

Blinking green: Normal status

Blinking red: Need to recharge the battery cartridge

Lighting-up-red: Recharge the battery cartridge. Nailing cannot be performed due to no remaining battery capacity.

Blinking orange after blinking green and red alternately: Fault detection is running. Remove and reinsert the battery cartridge to reset. If fault detection is running again, it is malfunction condition. Ask your local Makita service center to repair it.

Hook

⚠CAUTION:

Always remove the battery when hanging the tool. Do not hang the tool to your belt.

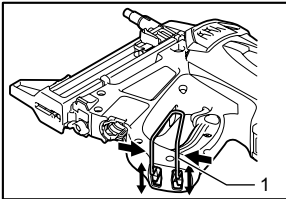

1. Hook

013156

The hook is convenient for hanging the tool temporarily. The hook can be set in two positions according to where the tool will be hung.

To change the hook position, push its feet in from both sides and shift to another position.

ASSEMBLY

⚠CAUTION:

- Always remove the fuel cell and the battery cartridge before carrying out any work on the tool.

Loading the nailer

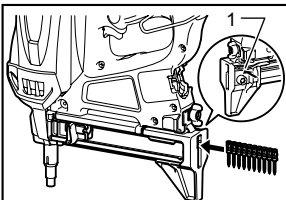

1. Button

013157

Insert a strip of nails into the slit in the rear of the magazine. The nails stop at the entrance of the

magazine because of the nail stopper. Unlock the magazine by pressing the button of the nail stopper to insert the nails.

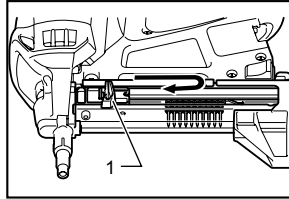

1. Pusher lever

013158

Pull the pusher lever with pressing the pusher button all the way to the rear of the magazine. Then release the pusher button, and return the pusher lever to the end of the strip gently.

Removing nails

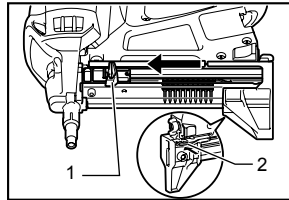

1. Pusher lever
2. Nail stopper

013159

Pull the pusher lever and push the pusher button to release the nail supporter, and then return the pusher lever to the top with pushing the pusher button.

Slide the nails toward the rear of the magazine. The nails stop at the entrance of the magazine because of the nail stopper. Unlock the magazine by pressing the button of the nail stopper to remove the nails.

Changing the magazine (optional accessory)

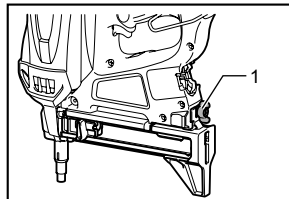

1. Bolt

013165

A magazine with different length is available as optional accessory.

To change the magazine, loosen the bolt and remove the magazine. Then install the new magazine. And fasten the bolt on the magazine.

OPERATION

⚠WARNING:

- Do not touch around the exhaust vent. The surface will be very hot during or after an operation. Touching around the exhaust vent may cause burns or injuries.

⚠CAUTION:

- Make sure all safety systems are in working order before operation.

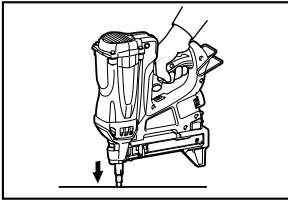

013160

1. To drive a nail, place the contact element against the workpiece.

The fan motor is activated, fuel gas is injected into combustion chamber and mixed with air by the fan.

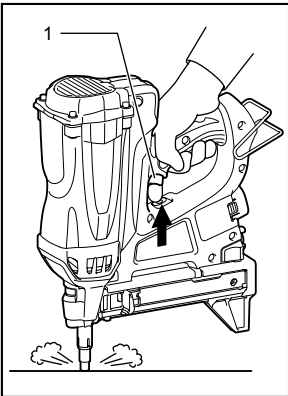

013161

2. Hold the contact element pressing firmly and pull the trigger.

Fuel gas is combusted and the nail is driven.

3. Further driving can be initiated only after both the contact element and the trigger are released.

Nail-driving of concrete

⚠WARNING:

- Use hardened nails only for concrete. Using other purposed nails may cause serious injuries. Do not nail directly on the concrete.

Failure to do so may cause concrete fragments to fly off or nails to strike back, causing serious injuries.

- When driving nails, hold the tool so that it stands upright to the driving surface. Slanted nail-driving may cause concrete fragments to fly off or nails to strike back, causing serious injuries.
- Do not use the tool on the surface that objects hang from, such as area where hangers for sewer pipe, dust pipe etc. are set up

Choose and use appropriate nails so that the penetration amount into concrete ranges 15 mm - 20 mm.

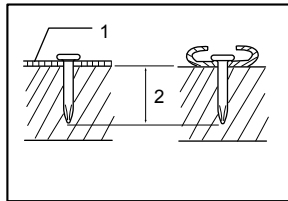

1. Thin steel plate
2. Penetration amount into concrete

010319

⚠CAUTION:

- Use this tool only for soft concrete built up not so long before. Using on the hard concrete may cause nail bending or nail-driving to insufficient depth.
- When the penetration amount into concrete is required more than 20 mm, driving nails to the sufficient length may not be obtained. Nails may be driven too shallow causing unstable workpiece, resulting in personal injury and damage to property.

Anti dry fire mechanism

This mechanism prevents the tool from firing without nail.

Dry fire prevention automatically functions when the rest of nails get to the last 2-3 pieces.

Jammed nailer

⚠WARNING:

- Always be sure to remove the fuel cell and the battery cartridge before clearing a jam.

⚠CAUTION:

- Do not use deformed nails or nail strip. Failure to do so causes poor nail feeding.

Follow the removing nail procedure and remove the jammed nails.

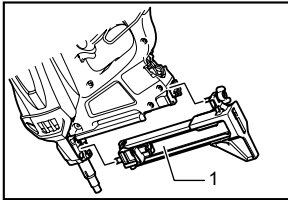

1. Magazine

013166

Remove the fuel cell, the battery cartridge and nails. Loosen the bolt on the magazine. Remove the magazine and remove the jammed nails.

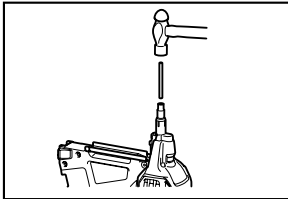

013163

If the nails cannot be removed after performing above method, do as follows.

Insert a small rod or the like into the ejection port and tap it with a hammer to drive out the jammed nails from the ejection port.

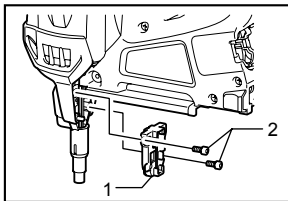

1. Under driver guide
2. Bolt

013227

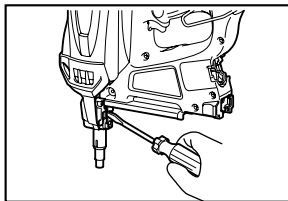

013164

If the nails still remain in the ejection port, do as follows. Loosen the bolts on the ejecting port by using a hex wrench. Remove the under driver guide. And remove the jammed nails.

Return the under driver guide and tighten the bolts after the jammed nails are removed. Return the magazine and tighten the bolt.

MAINTENANCE

⚠CAUTION:

- Always remove the fuel cell, the battery cartridge and nails before attempting to perform inspection or maintenance.
- Never use gasoline, benzene, thinner, alcohol or the like. Discoloration, deformation or cracks may result.

Maintenance after daily work

At the end of daily work, conduct an end-of-workday routine.

These simple steps are based on maintaining the safety and performance of the tool.

Before leaving the work site:

- Remove the battery cartridge and store in a tool-carrying case. Always use the tool-carrying case for transporting and storing the tool.
- Dispose of all empty cells where they will not be found by children, crushed, punctured or burned.

When you get home:

- Place the battery cartridge in its charger if it needs charging as indicated by the red indication lamp.
- Wipe the tool with a clean, soft cloth.
- Check the filter and clean if it is dusty.

Cleaning the air filter

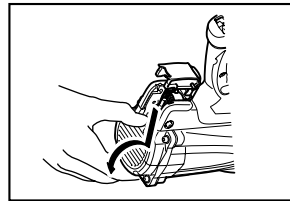

013226

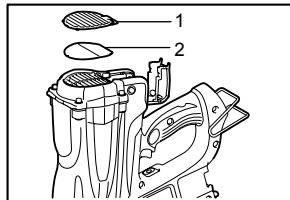

1. Filter cover
2. Filter

013162

Press slightly up the filter cover and remove it. And then simply lift out the filter.

Tap the filter lightly to remove any dust. Soap and water restores the filter to an almost new condition

To maintain product SAFETY and RELIABILITY, repairs, any other maintenance or adjustment should be performed by Makita Authorized Service Centers, always using Makita replacement parts.

Thoroughly cleaning

If dry fires occur frequently, which means the tool is needed to be cleansed thoroughly.

See the accompanying cleaning guide for detail, and perform the cleaning.

If you have any questions regarding to cleaning, please ask your local Makita Service Center.

OPTIONAL ACCESSORIES

CAUTION:

- These accessories or attachments are recommended for use with your Makita tool specified in this manual. The use of any other accessories or attachments might present a risk of injury to persons. Only use accessory or attachment for its stated purpose.

If you need any assistance for more details regarding these accessories, ask your local Makita Service Center.

- Nails
- Magazine
- Safety goggles
- Fuel cell
- Cleaning kit
- Makita genuine battery and charger

NOTE:

- Some items in the list may be included in the tool package as standard accessories. They may differ from country to country.

Makita Corporation
Anjo, Aichi, Japan

885157-222

www.makita.com